

एसजेवीएन अरुण-3 पावर डवलपमेंट कंपनी प्रा. लि.
SJVN Arun-3 Power Development Company Pvt. Ltd.

(एसजेवीएन की पूर्ण स्वामित्व वाली अधीनस्थ कंपनी)

(A wholly owned subsidiary of SJVN)

900 मेगावाट अरुण-3 जलविद्युत परियोजना
900 MW Arun-3 Hydro Power Project

Regd. No.: 111808/69/070



Ref. No.: SAPDC/P&C/Arun-3 HEP/PCD-236/2023-224

Dated:19.04.2023

Notice Inviting Tender (NIT) & Instructions to Bidders (ITB)

1.0 SJVN Arun-3 Power Development Company (P) Ltd. (**SAPDC/Employer**), Tumlingtar, Nepal (A Subsidiary of SJVN a joint venture of GOI & H.P.) having Registered office at Kathmandu, Nepal invites Sealed Bid under single stage two Envelopes bid system on item rate basis from the eligible Bidders/Contractors/Individual of Nepal for the following work:

1.	Name of Work	Restoration of Amrang water Supply Scheme at Amrang Makalu RM-5 & restoration of Baripal-Mangtankha water supply scheme and Baripal-Mangtankha Foot Path.
1.1	Tender No.	PCD-236/2023
1.2	NIT reference	PCD-236/2023
1.3	Time Allowed for Completion of whole of the works	Total time for completion of work has been kept 04 (Four) months to be reckoned from the 15 th day of issuance of Letter of Acceptance.
1.4	Estimated Cost	NPR 21,95,722/- (Inclusive of VAT)
1.5	Cost of Bidding Document (Non-refundable).	NPR 1,000/- in the form of bank draft/Manager's cheque payable at Khandbari, Nepal in favour of SAPDC-NPR CONSTRUCTION ACCOUNT
1.6	<i>Deleted without change in Sr. No.</i>	<i>Deleted without change in Sr. No.</i>
1.7	Earnest Money Deposit/Bid Security	NPR 44,000/- (to be submitted as per clause no. 14).
1.8	<i>Deleted without change in Sr. No.</i>	<i>Deleted without change in Sr. No.</i>
1.9	Last date & time for submission of Bid(s).	19.05.2023 Time: 1500 Hours.
1.10	Time and Date for opening Technical Bid(s).	21.05.2023 Time: 1600 Hours.
1.11	Time and Date of opening Financial Bid(s).	To be intimated separately on websites only.
1.12	Bid validity period	The bids shall remain valid for acceptance for a period of 180 days from the date of opening of Techno-Commercial Bids.

1.13	Place of submission/opening bid/Bids	<p style="text-align: right;">Chief Engineer (P&C), Satluj Bhawan, Arun Sadan, SAPDC, Arun-3 HEP, Tumlingtar, Distt. Sankhuwasabha, Nepal. Phone: +977-29-575154, E-mail Address: pnc.sapdc@gmail.com</p>
1.14	Authority/Officer inviting Tender	

2.0 Eligibility

Bidders/Contractors/Individual must be residents of four Gaunpalikas namely Makalu Gaunpalika, Chichila Gaunpalika, Bhotkhola Gaunpalika and Silichong Gaunpalika of Distt. Shankhuwasabha, Nepal.

3.0 Time for completion

The time for completion of work shall be as per para 1.3 NIT & ITB.

4.0 Interested Bidders may download the Tender documents from <http://sjvn.nic.in/tender.htm> or www.sapdc.com.np and submit their offer along with the cost of Tender Document and EMD as mentioned under para 1.5 & 1.7 herein-above respectively.

5.0 Cost of Bidding

The bidder shall bear all costs associated with the preparation and submission of his bid and SAPDC will in no case be responsible or liable for these costs, regardless of the conduct or outcome of the bidding process.

6.0 Site Visit

6.1 The Bidder is advised to visit and examine the Site of Works and its surroundings and obtain for itself, on his own responsibility, all information that may be necessary for preparing the bid. The bidder shall assess and satisfy himself as to the adequacy of the local conditions such as approach roads to the site, adequacy of existing culverts/ bridges/ roads for the expected traffic, water and power supply, nature of ground and sub-soil conditions, water table level, accommodation required during the Contract, river, geological and climate conditions, local terrain, availability of labour, construction materials, details of taxes, royalties duties and levies as applicable in Nepal and any other information required. The costs of visiting the Site shall be at the Bidder's own expense.

6.2 The bidder and any of his personnel or agents will be granted permission by the SAPDC to enter upon its premises and lands for the purpose of such inspection but only upon the express condition that the bidder, his personnel or agents shall release and indemnify the SAPDC and its personnel and agents from and against all liability in respect thereof and shall be responsible for personal injury (whether fatal or otherwise), loss of or damage to property and any other loss, damage, cost and expenses however caused, which, but for the exercise of such permission would not have arisen.

7.0 The bidder is expected to examine carefully all instructions, terms and conditions, Performa, specifications and drawings in the Bidding Documents. Failure to comply with the requirements of bid documents shall be at the bidder's own risk. However, after study of the documents if the bidder notices any error in typing, spellings and/or any omission the same can be brought to the notice of Employer at least 15 days prior to the deadline for submission of bids. It shall be the sole discretion of the Employer to consider such errors/omissions for which necessary corrigendum will be issued.

8.0 Clarification of Bidding Documents

A prospective bidder requiring any clarification of the bidding documents may notify to the Chief Engineer (P&C), SAPDC, Arun-3 HEP, Satluj Bhawan, Arun Sadan, Tumlingtar, Distt. Sankhuwasabha, Nepal. Ph: +977-29-575154.

9.0 Amendment of Bidding Documents

- 9.1 At any time prior to the deadline for submission of bids, the SAPDC may amend the Bidding Documents by the issuance of an addendum/corrigendum.
- 9.2 The corrigendum's and amendments if any shall be uploaded only on <http://sjvn.nic.in/tender.htm> or www.sapdc.com.np, all the bidders are requested to frequently visit the web sites till the schedule date of submission of bid.
- 9.3 The addendum thus issued shall be part of the bidding documents and shall be communicated to all prospective bidders who have purchased the Bidding Documents. Prospective bidders shall promptly acknowledge receipt thereof to the SAPDC.
- 9.4 In order to afford prospective bidders reasonable time in which to take an addendum into account for preparing their bids, the SAPDC may, at its discretion extend, as necessary, the deadline for submission of bids in accordance with Para-18 hereof.

10.0 Language of bid

The bid prepared by the bidder and all correspondence and documents thereto exchanged by the bidder and the SAPDC be written in English language. Supporting documents and printed literature furnished by the bidder with the bid may be in another language provided these are accompanied by an appropriate translation of pertinent passages in English language. For the purpose of interpretation of the bid, the English language shall prevail.

11.0 Bid Prices

- 11.1 Unless stated otherwise in the Bidding Documents, the Contract shall be for the whole Works as described in the Bidding Documents based on Priced Schedule/Bill of Quantity submitted by the bidder.
- 11.2 The bidder shall offer rates & prices inclusive of VAT and all other taxes & duties etc "on Firm Price Basis" in the Priced Schedule/Bill of Quantities of the Bidding documents and shall not be subject to adjustment on any account.
- 11.3 The rates and amounts shall be quoted in decimal in such a manner that no interpolation is possible. The rates and amounts shall be written both in words and figures. In case of ambiguities in between the rate in figures and the rate in words, the rate quoted in words shall prevail and the amount shall be corrected accordingly. The SAPDC reserves the right to adjust arithmetical or other errors in any tender/quotation in the way which it considers suitable. Corrections, if any, shall be made by crossing out, initialing, dating and rewriting. Corrections by applying correcting fluid shall not be permitted.
- 11.4 The bidder shall fill in unit rates and prices for all items of Works described in the Bill of Quantities/Priced Schedule. Items against which no rate or price is entered by the bidder will not be paid for by the SAPDC when executed, and shall be deemed to be covered by the other rates and prices in the Bill of Quantities/Priced Schedule. However, the rate for excess over quantities of such items beyond deviation limit prescribed under the contract will be worked out in accordance with the provisions contained in the Contract.
- 11.5 Only unconditional discount offered by the Bidder on the Performa for Price Bid shall be considered for evaluation.
- 11.6 As regards the Income Tax, Surcharge on income tax, VAT & any other Taxes as applicable in Nepal, SAPDC shall not bear any Tax liability whatsoever. The Bidder shall be liable and responsible for payment of such Taxes if applicable under the provision of law at present or in

future in Nepal. SAPDC will deduct TDS (Tax deductions at Source) as applicable. The details/information towards the deductions shall be issued by SAPDC.

12.0 Currencies of Bid and Payment

The unit rates and prices shall be quoted by the bidder entirely in Nepalese Rupees (NPR) and the payment shall also be made in Nepalese Rupees (NPR).

13.0 Bid Validity Period

13.1 Bids shall remain valid for acceptance for a period of 180 days (one hundred eighty days) from the date of opening of Techno-Commercial Bids prescribed in Para-21.0 hereof.

13.2 The SAPDC may request the bidders to extend the period of validity for a specified additional period. The request and the bidder's response shall be made in writing. A bidder may refuse the request without forfeiting his bid security. A bidder agreeing to the request will not be permitted to modify his bid, but will be required to extend the validity of his bid security for the period of the extension and in compliance with Para-14.0 hereof in all respects.

14.0 Bid Security/Earnest Money Deposit (EMD)

- (i) Earnest Money shall be submitted in the shape of Bank Draft/Manager Cheque/FDR (duly pledged in favour of **SAPDC-NPR CONSTRUCTION ACCOUNT**) payable at Khandbari/**Bank Guarantee** in favor of **SAPDC-NPR CONSTRUCTION ACCOUNT** (Acceptable to SAPDC) for an amount as mentioned at para 1.7 herein-above. Bank Guarantee may be in the format provided in tender document. Earnest Money Deposit shall remain valid for 180 days after the date of deadline for submission of Bids as stated in the invitation to bid.

Any bid not accompanied by an acceptable Earnest Money Deposit shall be declared non-responsive and rejected by the Employer and their Part-II (Price Bid) bid shall not be opened.

- (ii) EMD of the bidder shall be forfeited, if the bidder withdraws or amends its bid or impairs or derogates from the bid in any respect within the period of validity of the bid.
- (iii) The EMD of the successful bidder shall be return within 28 days after submission of performance security and signing of contract agreement.
- (iv) The EMD of unsuccessful bidders will be returned within 28 days of the award of work to the successful bidder.
- (v) No interest shall be payable by SAPDC on EMD/ performance security.

15.0 Variation in Bidding Conditions

Bidder shall submit offers which comply fully with the requirements of the Bidding Documents. Bids which take deviations from the conditions of the contract will not be considered.

16.0 Signing of bid

16.1 The bid shall be typed or written in indelible ink and shall be signed by a person or persons duly authorized to sign on behalf of the bidder. All the pages of the bid shall be signed and stamped at the lower right-hand corner by the person or persons signing the bid.

16.2 The bid shall not contain any alterations or additions or deletions except those to comply with the instructions issued by the Employer or as necessary to correct errors made by the bidder in which case, such corrections shall be initialed by the person or persons signing the bid.

17.0 Documents comprising the bid and manner of Submission thereof:

17.1 The bid shall consist of two parts as under:

Part –I (Envelope-I): Techno-commercial bid (excluding price bid).

- i. Bid Security/EMD in the form and amount as per bid conditions (as per Sr. No 14.0)
- ii. Cost of Tender Document (as per Sr. No. 1.5).
- iii. Duly filled in stamped and signed by authorized signatory:
 - a) Tender Form,
 - b) Form of Declaration,
 - c) Undertaking regarding Blacklisting
 - d) Bank Account detail
- iv. Document/Praman patra which substantiate the bidders/Contractors/Individual is residents of four Gaunpalikas namely Makalu Gaunpalika, Chichila Gaunpalika, Bhotkhola Gaunpalika and Silichong Gaunpalika of Distt. Shankhuwasabha, Nepal.
- v. Photo copy of VAT/PAN Number/Registration certificate.

Part – II (Envelope-II): Price Bid

Comprising of Price Bid, duly filled in & signed Bill of Quantities (BOQ).

17.2 A rate or price shall be entered against each item in the priced Bill of Quantities (Price Schedule), whether quantities are stated or not. The cost of items against which the Contractor has failed to enter a rate or price shall be deemed to be covered by other rates and prices entered in the Bill of Quantities (Price Schedule).

17.3 In the “Techno-Commercial” part of the bid the bidder shall not give any indication about the bid price in any manner whatsoever. Non-compliance of this provision may result in the rejection of bid.

17.4 The part II of the bid (i.e. Price bid) shall be strictly in accordance with the forms provided in the Bill of Quantities /Price Schedule.

17.5 The bidder shall not take any deviation from the bid conditions.

17.6 The bidder shall also fill, sign and stamp each page of the documents forming part of the bid, on the left hand cover (bottom side).

17.7 The Part-I & Part-II of the bids shall be packed and submitted in the following manner.

- i. Part-I & Part-II of the bids shall be kept in separate sealed envelopes/covers duly super scribed with the “The Part-I (Techno Commercial Bid including Bid security, Cost of Tender Document) and Part-II (Price Bid).

On upper left hand corner.

- i. Bid for (Name of Work)
- ii. Do not open before *{insert last date of submission}*
- iii. To be opened by tender committee only.

In the center of the cover.

Name of the person/ officer and the office address to whom bid is addressed.

On the bottom left hand corner:

Name and address of the bidder.

17.8 The bids as above shall be submitted either in person or through courier or by post to following address:-

**Chief Engineer (P&C),
Arun-3 HEP, SAPDC, Satluj Bhawan, Arun Sadan,
Tumlingtar, Distt. Sankhuwasabha, Nepal
Ph. +977-29-575154**

However, SAPDC not be responsible for any delay in receipt due to any reason whatsoever and/ or for loss of the bid in postal transit.

18.0 Dead line for Submission of Bids

- 18.1 The bids shall be received by the SAPDC not later than the time & date at the address specified at Para 1.9 and 1.13 here-in above.
- 18.2 The SAPDC may extend the deadline for submission of bids by issuing an amendment in accordance with Para 9.0 hereof, in which case all rights and obligations of the SAPDC and the bidders previously subject to the original deadline will then be subject to the new deadline.

19.0 Late/Delayed Bids

Any bid received by the SAPDC after the deadline prescribed by the SAPDC in accordance with Para-18.0 hereof will be returned un-opened to the bidder.

20.0 Modification and Withdrawal of Bids

- 20.1 The bidder may modify or withdraw his bid after bid submission, provided that the modification or notice of withdrawal is received in writing by the SAPDC prior to the prescribed deadline for submission of bids.
- 20.2 The bidder's modification or notice of withdrawal shall be prepared, sealed, marked and delivered in accordance with the Para 16.0 & 17.0 hereof, with the inner envelopes additionally marked "Modification" or "Withdrawal" as appropriate.
- 20.3 Subject to Para-22.0, no bid may be modified subsequent to the deadline for submission of bids.
- 20.4 Withdrawal/Modification of bid between the deadline for submission of bids and the expiry of the period of bid validity or as extended pursuant to Para-13.0 hereof shall result in the forfeiture of the bid security pursuant to Para-14.0 hereof.

21.0 Bid Opening

- 21.1 Bids for which an acceptable notice of withdrawal has been submitted pursuant to Para-20.0 hereof shall not be opened.
- 21.2 Then, the Part-I of the bid i.e., the envelope containing bid security & cost of tender document and the document as per 17.1 of ITB shall be opened. The bids whose bid security/ cost of tender document is either deficient in value and/ or form, will be rejected out rightly & will not be evaluated further. The envelope of modification pursuant to Para-20 hereof, if any, to this part of bid shall be opened first.
- 21.3 The "Price Bid" (Part-II of the bid) shall be opened at a subsequent date for which a separate intimation will be sent. It will be discretion of the SAPDC to invite all the bidders to be present at the time of opening of price bids or only those bidders whose bids are ascertained to be techno-commercially responsive. The envelope of modification pursuant to Para-20 hereof, if any, to this part of bid shall be opened first.
- 21.4 Bidder's authorized representatives may attend the bid opening. The officers of the SAPDC authorized for opening of bids will announce the bidder's name, written notifications of bid withdrawal if any, the presence or absence of the requisite bid security, the deviations taken by the bidder's etc., and any such detail as the said officer(s) may consider appropriate. The bidder's representative(s) shall sign register provided by SAPDC for evidencing their participation in the process of bid opening.

22.0 Clarification of Bids

To assist in the examination, evaluation and comparison of bids, the SAPDC may ask bidders individually for clarification of their bids. The request for clarification and the response shall be in writing or by email, but no change in the price or substance of the bid shall be sought, offered or permitted except as required to confirm the correction of arithmetic errors discovered by the SAPDC during the evaluation of the bids in accordance with sub-Para-24.1 hereof.

23.0 Determination of Responsiveness & Techno-Commercial evaluation

23.1 Prior to the detailed evaluation of bids, the SAPDC will determine whether each bid:

- i) meets the eligibility requirements set out under Para 2.0 hereof;
- ii) has been properly signed by an authorized Signatory.
- iii) is accompanied by the required securities, and
- iv) is substantially responsive to the requirements of the bidding documents.

23.2 A substantially responsive bid is one, which conforms to all the terms, conditions and specifications of the Bidding Documents without material deviation or reservation. A material deviation or reservation is one:

- i) which affects in any substantial way the scope, quality, or performance of the Works;
- ii) which limits in any substantial way, inconsistent with the Bidding documents, the SAPDC rights or the bidder's obligations under the Contract; or
- iii) whose rectification would affect unfairly the competitive position of other bidders presenting substantially responsive bids.

23.3 If a bid is not substantially responsive, it will be rejected by the SAPDC and may not subsequently be made responsive by correction or withdrawal of the non-conforming deviation or reservation or by submission of subsequent clarifications.

24.0 Commercial evaluation

24.1 Bids determined to be substantially responsive will be checked by the SAPDC for any arithmetic errors. Errors will be corrected by the SAPDC as follows:

- i) where there is a discrepancy between unit rate in figures and in words, the unit rate in words will govern; and
- ii) Where there is a discrepancy between the unit rate and the line item total resulting from multiplying the unit rate by the quantity, the unit rate as quoted in words will govern.
- iii) In case error due to wrong extension of quantities, the quantities as specified in the Bid documents will be considered and multiplied by the unit rates quoted in words to obtain the amount.

24.2 The amount stated in the Bid will be adjusted by the SAPDC in accordance with the above procedure for the correction of errors and shall be considered as binding upon the bidder. If the bidder does not accept the corrected amount of bid, his bid will be rejected and the bid security shall be forfeited.

24.3 Evaluation and Comparison of Bids

24.3.1 The SAPDC will evaluate and compare only the bids determined to be substantially responsive to the requirements of the Bidding Documents in accordance with Para-23.0 hereof.

24.3.2 In evaluating bids, SAPDC will determine, for each bid, the Evaluated Bid Price by adjusting the bid price as follows.

- i) Making any correction for errors pursuant to sub-Para-24.1 hereof;

- ii) Making an appropriate adjustment to reflect discounts or other price modifications offered in accordance with Para-20.0 hereof.
- iii) Making an appropriate adjustment for the discount offered by the Bidder. Only unconditional discount offered by the bidder on the Performa for Price Bid shall be considered.

25.0 Award Criteria

Subject to Para-26.0 hereof, the SAPDC will award the contract to the bidder whose bid has been determined to be substantially responsive to the Bidding documents and who has offered the lowest evaluated bid price pursuant to Para-24.0 hereof and the evaluated Bid Price is within a reasonable variation of the estimated cost of tendered Works.

26.0 SAPDC Right to accept any Bid and to reject any or All Bids

Notwithstanding Para-25.0, the SAPDC reserves the right to accept or reject any bid or to annul the bidding process and reject all bids, at any time prior to award of Contract, without thereby incurring any liability to the affected bidder or bidders or any obligation to inform the affected bidder or bidders of the grounds for the SAPDC action.

27.0 Notification of Award

27.1 Prior to the expiration of the period of bid validity prescribed by the SAPDC or any extension thereof, the SAPDC will notify the successful bidder in writing that his bid has been accepted. This letter (hereinafter and in the Conditions of Contract called "Letter of Acceptance") shall name the sum which the SAPDC will pay to the Contractor in consideration of the execution, completion and maintenance of the Works by the Contractor as prescribed by the Contract (hereinafter and in the Conditions of Contract called "the Contract Price").

27.2 The notification of award will constitute the formation of the Contract.

28.0 Signing of Agreement

28.1 Within thirty (30) days from issuance of Letter of Acceptance, on a date and time mutually agreed upon, the successful bidder or his authorized representative shall attend the Office of Chief Engineer (P&C), Arun Sadan, SAPDC Office Complex, Tumlingtar, Nepal for signing of the Agreement.

28.2 Failure on the part of the successful bidder to comply with the requirements of this Para will constitute sufficient grounds for the annulment of the award and forfeiture of the bid security.

29.0 Performance Security

- a) Contractor shall furnish a "Performance Security" in favour of **SAPDC-NPR CONSTRUCTION ACCOUNT**, towards contract performance security within 30 days from the issue of letter of award in one of the form as detailed below: -
 - i) Bank Draft/Manager Cheque/FDR (duly pledged in favour of **SAPDC-NPR CONSTRUCTION ACCOUNT**)
 - ii) An irrevocable valid and fully enforceable Bank Guarantee from a Commercial (Class A) bank of Nepal in favour of **SAPDC-NPR CONSTRUCTION ACCOUNT** acceptable to SAPDC.
- b) The Performance Security amount shall be equal to 5% of the Contract Price for the faithful performance of the contract in accordance with the terms and conditions specified in the contract. The guarantee shall be valid till 45 days beyond Defect Liability Period. The above contract performance guarantee shall be liable for forfeiture in case of failure of the bidder to fulfill its contractual obligations under the contract.

- c) The performance guarantee will be returned to the contractor within 30 days after Defect Liability Period without any interest and “Satisfactory Performance Certificate” issued by EIC (Engineer-in-Charge).

30.0 For any enquiry/clarification for submission of bid and any other information, the Bidders may contact to:

Name	Designation	Contact Nos.	Address
Er. Rakesh Singh	CE(P&C)	+977-29-575154	SAPDC, Arun-3 HEP, Satluj Bhawan, Arun Sadan, Tumlingtar, Distt. Sankhuwasabha, Nepal

FORMS

TENDER FORM

To

**Chief Engineer (P&C),
Satluj Bhawan, Arun Sadan,
SAPDC Office Complex, Tumlingtar.**

1. We have read and examined the following Bidding Documents relating to "Restoration of Amrang water Supply Scheme at Amrang Makalu RM-5 & restoration of Baripal-Mangtankha water supply scheme and Baripal-Mangtankha Foot Path."
 - (i) Notice Inviting Tender (NIT) & Information to Bidders (ITB)
 - (ii) Forms (Tender form, Form of declaration, Undertaking Regarding Blacklisting)
 - (iii) General Conditions of Contract (GCC)
 - (iv) Detailed Scope of work & Technical specifications
 - (v) Special Conditions of Contract (SCC)
 - (vi) Bill of Quantities (BOQ)
 - (vii) Tender Drawings
2. We hereby tender for execution of the work referred to in the documents mentioned in paragraph one above upon the terms and conditions contained or referred to in the aforesaid documents and in accordance in all respects with the specifications, designs, drawings and other details given herein and at the rates contained in BOQ and within the period(s) of completion and subject to such terms and conditions as stipulated in the enclosed Bidding Documents.
3. We agree to keep this tender open for acceptance for 180 days from opening of Techno-Commercial and also agree not to make any modifications in its terms and conditions on our own accord.
4. Earnest Money Deposit of requisite amount as specified in bidding document is hereby enclosed in the form of a Bank Draft/Manager Cheque/FDR (duly pledged in favour of **SAPDC-NPR CONSTRUCTION ACCOUNT**/Bank Guarantee in favor of **SAPDC-NPR CONSTRUCTION ACCOUNT** payable at Khandbari acceptable to SJVN Arun-3 Power Development Company Private Limited. We agree that if we fail to keep the validity of tender open, as aforesaid, or make any modification in the terms and conditions of our tender on our own accord and/or fail to commence the execution of the works as provided in the documents referred to in paragraph-1 above, after the acceptance of our tender, we shall become liable for forfeiture of our earnest money, as aforesaid, and the Employer shall without prejudice to any other right or remedy, be at liberty to forfeit the said earnest money absolutely.

Should this tender be accepted, we agree to abide by and fulfil all the terms and conditions and provisions of the above-mentioned Bidding Documents.

We certify that the Tender submitted by us is strictly in accordance with the terms, conditions, specifications etc. as contained in your Bidding Documents, referred to in paragraph-1 above, and it

does not contain any deviations to the aforesaid documents. It is further certified that information furnished in the Tender submitted by us is correct to the best of our knowledge and belief.

(Signature of person duly authorized to sign the Tender on behalf of the bidder along with Seal of Company)

Name _____

Designation _____

Contact No. /Email ID _____

Witness:

Name _____

Signature _____ Designation _____

Date _____ Name of Company _____

Name & Address _____

_____ Date: _____

Postal Address _____

Telegraphic Address: _____

Telephone No. _____ Telex _____

No. _____

Fax No. _____ e-mail _____

FORM OF DECLARATION

M/s.....(name of Bidder) having its registered office at
.....(hereinafter referred to as the Bidder) having
carefully studied all the Bidding Documents, specifications, drawings, the local and site conditions
etc. pertaining to the Work for "Restoration of Amrang water Supply Scheme at Amrang Makalu
RM-5 & restoration of Baripal-Mangtankha water supply scheme and Baripal-Mangtankha Foot
Path." and having undertaken to execute the said works,

DO HEREBY DECLARE THAT:

1. The Bidder is familiar with all the requirements of the Contract.
2. The Bidder has not been influenced by any statement or promise of any person of the Employer but only the Contract Documents.
3. The Bidder is financially solvent.
4. The Bidder is experienced and competent to perform the Contract to the satisfaction of Employer.
5. The Bidder is familiar with all general and special laws, acts, ordinances, rules and regulations of the Municipalities, District, State and Central Government of Nepal that may affect the work, its performance or personnel employed therein.
6. The Bidder hereby authorizes the Employer to seek reference from the bankers of Bidder for its financial position.
7. The Bidder undertakes to abide by all labour welfare legislations.
8. The information / statement submitted by the Bidder along with the bid is true and correct in all respects.

Date:

For and on behalf of the bidder

.....

**(Signature of authorized representative of the Bidder, along with his name,
Seal of Company)**

UNDERTAKING REGARDING BLACKLISTING

To,

**Chief Engineer (P&C),
Satluj Bhawan, Arun Sadan,
SAPDC Office Complex, Tumlingtar.**

Dear Sir,

It is hereby certified that, we {*Insert Name of Contractor/Firm*} as an individual or as a partner in JV are not blacklisted by Govt. of India/Govt. of Nepal & its undertaking as on date. The *Bidder/Firm* will immediately inform to Employer (SAPDC) in case of any change in the situation any time here in after.

We remain,

Yours sincerely,

Authorized Signature [*In full and initials*]: _____

Name and Title of Signatory: _____

Name of Bidder/Firm _____

Address: _____

Seal of the Bidder/Firm _____

BANK ACCOUNT DETAILS

Sr. No.	Particulars	#To be filled by bidder(s)
1.	Name of Bidder as per Bank record	
2.	Bank account number	
3.	Bank name	
4.	Branch address	

#Copy of cancelled cheque may also be attached

For and on behalf of the bidder /Supplier

.....

(Signature of authorized representative of the Bidder/Supplier, along with his name, Seal of Company)

GENERAL CONDITIONS OF CONTRACT (GCC)

1: DEFINITIONS:

In the contract, the following expression shall, unless the context otherwise requires, have the meanings thereby respectively assigned to them:

- (i) **Bill of Quantities or Schedule of Quantities & Prices:** means the priced and completed bill of quantities forming part of the Contract.
- (ii) **Contract Price:** means the amount arrived at by multiplying the quantities shown in the Bill of Quantities by the respective item rates as allowed and included in the Letter of Acceptance.
- (iii) **Contractor:** means the successful Bidder who is awarded contract to perform the work covered under these Bidding Documents and shall be deemed to include the Contractor's successors, executors, representatives or assigns.
- (iv) **Corporation or Employer:** means the SJVN Arun-3 Power Development Company Private Limited having its office at Tumlingtar, Distt, Sankhuwasabha, Nepal, and includes therein legal representatives, successors and assigns.
- (v) **Construction Drawing:** means such drawings approved in writing by the Engineer-in-Charge/ Employer and issued for actual construction of the Works from time to time by the Engineer-in-Charge.
- (vi) **Day:** means a calendar day beginning and ending at midnight.
- (vii) **Drawing:** means and shall include Tender drawing and Construction drawing.
- (viii) **Engineer-in-Charge/Engineer:** means the Engineering Officer nominated by the Employer or its duly authorized representative to direct, supervise and be in charge of the works for the purpose of this contract.
- (ix) **Letter of Award or Acceptance:** means a letter from the Employer conveying the acceptance of the tender/offer subject to such reservations as may have been stated therein.
- (x) **Specifications:** means the Technical specification of the Works included in the Contract and any modification thereof or addition thereto or submitted by the Contractor and approved by the Engineer.
- (xi) **Tender Drawings:** means the drawings referred to in the Specifications and/or appended with the Tender Documents.

2: INTERPRETATION

- 2.1 Words importing the singular only shall also include the plural; he includes she and vice versa unless this is repugnant to the context. Unless specifically defined, words shall have normal meaning under the language of Contract.
- 2.2 Heading and marginal notes in these General Conditions shall not be deemed to form part

thereof or be taken into consideration in the interpretation or construction thereof of the Contract.

- 2.3 Any error in description, quantity or price in Bill of Quantities or any omission there from shall not vitiate the Contract or release the Contractor from execution of the whole or any part of the Works comprised therein according to drawings and Specifications or from any of his obligations under the Contract.
- 2.4 Detailed drawings shall be followed in preference to small scale drawings (sketch drawings) and figured dimensions in preference to scaled dimensions. In the case of discrepancy between the Letter of acceptance issued by Employer, Special Conditions of Contract, Technical Specifications, General Conditions of Contract, the Tender Drawings and/or Bill of Quantities and other documents of Contract the following order of precedence shall prevail:
- a) Agreement
 - b) Letter of Acceptance;
 - c) Special Conditions of Contract;
 - d) General Conditions of Contract;
 - e) Detailed Scope of Work and Technical Specifications;
 - f) Priced Bill of Quantities;
 - g) Contractor's Bid other than BOQ;
 - h) Tender drawings;
 - i) Notice Inviting Tender & Instructions to Bidders; and
 - j) Any other document forming part of the Contract.

3.0 Contractor's Default

- (a) If the contractor shall neglect to execute the work with due diligence and expedition or shall refuse or neglect to comply with any reasonable order give to him in writing by the EIC in connection with the work or shall contravene the provisions of the contract, the Employer may give notice in writing to the contractor to make good the failure, neglect or contravention complained of, should the contractor fail to comply with the notice within fifteen (15) days from the date of service thereof, then and in such case the Employer shall terminate the contract and shall be at liberty to comply other contractor and forthwith execute such part of the work as the contractor may have neglected to do or if the Employer shall think fit, without prejudice to any other right he may have under the contract, to take the work wholly or in part out of the contractor's hands and re-contract with any other person or persons to complete the work or any part thereof and apply any balance payment which may otherwise be due on the contract by him to the contractor, or such part thereof as may be necessary, to the payment of the cost of executing the said part of the work or of completing the work as the case may be. If the cost of completing the work or executing a part thereof as aforesaid shall exceed the balance payment due to the contract, the contractor shall pay such excess. Such payment of excess amount shall be independent of the liquidated damages for delay, which the contractor shall have to pay if the completion of work is delayed and attributable to the contractor.
- (b) The termination of the contract under this clause shall not entitle the contractor to reduce the value of the contract performance security nor the time thereof. The Contract Performance Security shall be valid for the full value and for the full period or the completion of the Contract.

4.0 Suspension of work

The SAPDC reserves the right to suspend and reinstate execution of the whole or any part of the works without invalidating the provisions of the contract. Orders for suspension or

reinstatement of the works will be issued by SAPDC to the contractor in writing. The time for completion of the works will be extended for a period equal to the duration of the suspension. SAPDC shall not be responsible for any liabilities, if suspension or delay is due to some fault on the part of the contractor.

5.0 Deployment of labour

- i. The contractor will deploy regular/skilled workmen with experience of such type of work.
- ii. All traveling expenses including provision of all necessary transport to & fro from site, lodging, allowances and other payment to the experts/workmen shall be the sole responsibility of the contractor.
- iii. The contractor will comply with all acts/laws and other statutory provisions rules, regulations and byelaws as are applicable or which might become applicable with regard to the performance of the work and the engagement of the experts/workers. Minimum wage as notified by the Govt. of Nepal and amended from time to time shall be ensured by the Contractor for different labour categories.
- iv. The rates shall remain firm during the execution of the contract. No escalation shall be paid.
- v. The contractor will be responsible for compensation payable arising out of accidents including payment to third party, if involved, no compensation in case of accident / damages or for death / injury to the experts/workmen will be paid by the SAPDC.

6.0 Insurance

6.1 From commencement to completion of the Work(s) as a whole, the Contractor shall take full responsibility for the care thereof of work and for taking precautions to prevent any loss or damage. He shall be liable for any damage or loss that may happen to the Works or any part thereof and to the Employer's Plant, Equipment and Material (hired or issued to the Contractor). Any such loss or damage shall be restored in good order and condition and in conformity in every respect with the requirements of the Contract and instructions of the Engineer-in-Charge.

6.2 (i) Neither party to the Contract shall be liable to the other in respect of any loss or damage which may occur or arise out of "Force Majeure" to the Works or any part thereof or to any material or article at site but not incorporated in the Works or to any person or anything or material whatsoever of either party provided such a loss or damage could not have been foreseen or avoided by a prudent person and the either party shall bear losses and damages in respect of their respective men and materials. Liability of either parties shall include claims/compensation of the third party also.

(ii) Provided, however, in an eventuality as mentioned in sub-clause 6.2 (i) above, the following provisions shall also have effect:

- (a) The Contractor shall, as may be directed in writing by the Engineer-in-Charge proceed with the erection and completion of the works under and in accordance with the Contract; and
- (b) The Contractor shall, as may be directed in writing by the Engineer-in-Charge, re-execute the works lost or damaged, remove from the site any debris and so much of the works as shall have been damaged and carry the Employer's T&P, Equipment, Material etc. to the Employer's stores.

Provided always that the Contractor shall, at his own cost, repair and make good so much of the loss or damage as has been by any failure on his part to perform his obligations under the Contract or not taking precautions to prevent loss or damage or minimize the amount of such loss or damage.

6.3 The Contractor shall indemnify and keep indemnified the Employer against all losses and

claims for death, injuries or damage to any person or any property whatsoever which may arise out of or in consequence of the construction and maintenance of works during the Period for Completion for whole of the works and also against all claims, demands, proceedings, damages, costs, charges and expenses whatsoever in respect of or in relation thereto, and such liabilities shall include claims/compensations of the third party.

6.4 The Contractor shall avail 'group personal accident insurance policy' covering all the personnel employed by the Contractor for execution for Works complying requirement of Workmen Compensation Act applicable in Nepal. The minimum cover for personal injury or death insurance shall, however, be not less than as per requirements of the Labour Act of Nepal.

6.5 The Contractor shall provide, in the joint names of the Employer and the Contractor, insurance cover for an amount equal to 125% of the Contract Price/Award Value, from the Start Date to the end of the Defects Liability Period for the following events which are due to the Contractor's risks for any reasons whatsoever:

- a. Loss of or damage to the Works, Plant and Materials;
- b. Loss of or damage to Equipment;
- c. Loss of or damage to property (except the Works, Plant, Materials and Equipment) in connection with the Contract; and
- d. Personal injury or death.

The policy shall cover all physical loss or damage to the facilities and works at the Site, occurring prior to completion of the works/facilities, with extended maintenance coverage for the Contractor's liability in respect of any loss or damage occurring during the defect liability period while the Contractor is on the Site for the purpose of performing its obligations during the defect liability period.

6.6 Policies and certificates for insurance shall be delivered by the Contractor to the Engineer-in-Charge for the Engineer-in-Charge's approval before the Start Date. All such insurance shall provide for compensation to be payable in the types and proportions of currencies required to rectify the loss or damage incurred.

6.7 Alterations to the terms of insurance shall not be made without the approval of the Engineer-in-Charge.

6.8 Both parties shall comply with any conditions of the insurance policies.

6.9 The Employer shall be named as co-insured under all insurance policies taken out by the Contractor except for the Third-Party Liability, Workers' Compensation and Employer's Liability Insurances, and the Contractor's Subcontractors shall be named as co-insured's under all insurance policies taken out by the Contractor. All insurers' rights of subrogation against such co-insured's for losses or claims arising out of the performance of the Contract shall be waived under such policies.

7.0 Payment

- i. Running Account / Interim bills shall be submitted by the Contractor monthly on or before the date fixed by the Engineer-in-Charge for the work executed after compliance of all statutory provisions and complete in terms of contract conditions. The Engineer-in-Charge shall then verify the bills with reference to the measurements recorded in the measurement book(s).
- ii. Payment on account for amount admissible shall be made on the Engineer-in-Charge certifying the sum to which the Contractor is considered entitled by way of interim payment for the work executed, after deducting there from the amounts already paid, the Retention Money and such other amounts as may be withheld/deductible or recoverable in terms of the Contract.

- iii. **Retention money shall be deducted by the Engineer-in-Charge from the interim bills of the Contractor @ 5% (five percent)** of the total value of each bill of the work done towards security deposit. The retention money shall be returned after issuance of completion certificate by the EIC. No interest on the amount of retention money shall be paid to the Contractor at the time of release of retention money as stated above
- iv. Payment of the Contractor's bills shall be made by the Employer within 30 days from the date of submission of the bill subject to the acceptance of the Engineer-in-Charge.

8.0. VAT/Taxes & duties

The quoted rates shall be inclusive of all taxes and duties including VAT and SAPDC shall not bear anything extra on this account.

9.0 Force Majeure

The term "Force Majeure" shall herein mean riots (other than among the Contractor's employees), Civil Commotion (to the extent not insurable), war (whether declared or not), invasion, act of foreign enemies, hostilities, civil war, rebellion, revolution, insurrection, military or usurped power, damage from aircraft, nuclear fission, acts of God, such as earthquake (above 7 magnitude on Richter Scale), lightning, unprecedented floods, fires not caused by Contractor's negligence and other such causes over which the Contractor has no control and are accepted as such by the Engineer-in-Charge, whose decision shall be final and binding. In the event of either party being rendered unable by Force Majeure to perform any obligation required to be performed by them under this contract, the relative obligation of the party affected by such Force Majeure shall be treated as suspended for the period during which such Force Majeure cause lasts, provided the party alleging that it has been rendered unable as aforesaid, thereby shall notify within 10 days of the alleged beginning and ending thereof giving full particulars and satisfactory evidence in support of such cause.

Extension of time without levy of LD shall be provided during the period of occurrence of Force Majeure event, however no cost compensation shall be provided.

10.0 DEVIATIONS

- 10.1 The Engineer-in-Charge shall have powers to make any deviations in the original specifications or drawings or designs of the works or any part thereof that are, in his opinion, necessary at the time of or during the course of execution of the Works. For the aforesaid purpose or for any other reason, if it shall, in the opinion of the Engineer-in-Charge, be desirable, he shall also have the powers to make Deviations, such as (i) Variations (ii) Extra (iii) Additions/Omissions and (iv) Alterations or Substitutions of any kind. No such Deviations in the specifications or drawings or designs or Bill of Quantities, as aforesaid, shall in any way vitiate or invalidate the Contract and any such Deviations which the Contractor may be directed to do shall form integral part of the Contract as if originally provided therein and the Contractor shall carry out the same on the same terms & conditions in all respects on which he agreed to do the works under the contract subject to clause 10.2 of the bid.
- 10.2 The rates for such items of work as are required to be executed due to Deviations, as stated in sub-clause 10.1 above shall be payable in the manner as stated hereunder:
 - i) The rates already provided in the Bill of Quantities, shall apply in respect of the same item(s) of work to be executed due to Variation, subject to the condition that change in quantity multiplied by BOQ rate do not exceed 0.25 % of the Contract Price. However, the quoted rates shall hold good for all minus Variations.
 - ii) In case of items for which rates are not available in the Bill of Quantities, the rates of such items as far as practicable, shall be derived from the quoted rates of analogous item(s) in the

Bill of Quantities.

- iii) In the cases, where analogous items are not available in the Bill of Quantities, such items shall be termed as extra items and the rates for such items and also for items exceeding the prescribed limit as mentioned in clause 10.2 (i) above, the Contractor, within 15 days (or as agreed by the EIC) of receipt of order to execute such items shall submit rate analysis to the Engineer-in-Charge supported by documentary evidence of basic rates adopted therein, notwithstanding the fact that the rates for such items exist in the Contract, having regard to the cost of materials (including transportation and taxes, levies if paid), actual wages for labour and ownership & operational cost of construction equipment as per standard norms or if standard norms are not specified/available then on the basis of labour/materials/equipment actually engaged for the particular work. The standard norms for materials, machinery and labour specified herein shall mean rates specified in 'Norms for Rate analyzed' of DoR, GoN and applicable local rates. In case rates are not available in above said system Engineer-in-Charge may finalize such rate(s) and rate so derived shall be binding on the Contractor.

Over and above the cost of labour, material arranged by the Contractor and ownership & operational cost of plant and machinery, an element of such percentage as 15 % shall be allowed to cover the Contractor's overheads, profits, and supervision charges.

The Engineer-in-Charge shall examine the rate analysis submitted by the Contractor and fix the rates accordingly whose decision shall be conclusive, final and binding on the Contractor.

- 10.3 If requested by the Contractor, the Time for Completion of the Works shall, in the event of any deviation resulting in additional cost over the Contract Price, be extended in the proportion which the altered, additional or substituted work bears to the original Contract Price plus such further additional time as may be considered reasonable by the Engineer-in-Charge.
- 10.4 Under no circumstances, the Contractor shall suspend the work on account of non-settlement of rates of such Deviated items.
- 10.5 Provided that no deviations instructed to be done by the Engineer – in – charge pursuant to Clause 10.1 shall be valid under Clause 10.2 unless within 15 days of the date of such instruction before the commencement of execution of deviated items, notice shall have been given either;
- a) By the Contractor to the Engineer – in – Charge of an intention to Claim extra payment or varied rate or price or
 - b) By Engineer – in – Charge to the Contractor of his intention to vary a rate or price for the deviated items.

11 FORECLOSURE OF CONTRACT IN FULL OR IN PART DUE TO ABANDONMENT OR REDUCTION IN SCOPE OF WORK

- 11.1** If at any time after acceptance of the tender the Employer decides to abandon or reduce the scope of the Works for reason whatsoever and hence does not require the whole or any part of the Works to be carried out, the Engineer-in-Charge shall give notice in writing to that effect to the Contractor, and the Contractor shall have no claim to any payment of compensation or otherwise whatsoever, on account of any profit or advantage which he might have derived from the execution of the Works in full but which he could not derive in

consequence of the fore- closure of the whole or part of the Works.

The Contractor shall be paid at Contract rates for full amount of the Works executed at Site and, in addition, a mutually agreed reasonable amount as certified by the Engineer-in-Charge for the items hereunder mentioned which could not be utilized on the Works to the full extent because of the foreclosure:

- (a) Any expenditure incurred on preliminary works, e.g. temporary access roads, temporary labour huts, staff quarters and site office; storage accommodation workshop, installation and dismantling of Construction Equipment (batching plant, crushing plant) and water storage tanks.
- (b) (i) The Employer shall have the option to take over Contractor's materials or any part thereof, either brought to site or of which the Contractor is legally bound to accept delivery from suppliers (for incorporation in or incidental to the Work), provided, however, the Employer shall be bound to take over the material or such portions thereof as the Contractor does not desire to retain. The cost shall, however, take into account purchase price, cost of transportation and deterioration or damage which may have been caused to materials whilst in the custody of the Contractor.
 - (ii) For Contractor's materials not retained by the Employer, reasonable cost of transporting such materials from Site to Contractor's permanent stores or to his other Works, whichever is less. If materials are not transported to either of the said places, no cost of transportation shall be payable.
- (c) If any materials issued by the Employer are rendered surplus, the same except normal wastage for the materials used in the works shall be returned by the Contractor to the Employer.
- (d) Reasonable compensation for transfer of T&P from Site to Contractor's permanent stores or to his other works whichever is less. If T&P are not transported to either of the said places, no cost of outward transportation shall be payable.

11.2 The Contractor shall, if required by the Engineer-in-Charge, furnish to him books of account, wage books, time sheets and other relevant documents as may be necessary to enable him to certify the reasonable amount payable under this condition.

11.3 In the event of foreclosure of the Contract, the advances released to the Contractor shall be recovered/adjusted by en-cashing Bank Guarantees (if applicable) submitted by the contractor against the advances, in appropriate proportion as due to the Employer.

12. COMPENSATION FOR DELAY

12.1 If the Contractor fails to complete the Work as per the completion period or any extended period as may be allowed, he shall without prejudice to any other right or remedy of the Employer on account of such default, pay as an ascertained/agreed compensation (Liquidated Damages) not by way of penalty an amount as stipulated in the SCC:

12.2 The amount of compensation may be adjusted/withheld/ deducted or set-off against any sum due or payable to the Contractor under this or any other contract with the Employer. The payment or deduction of such damages shall not relieve the Contractor from his obligation to complete the Works or from any other obligations and liabilities under the Contract.

13 DEFECTS LIABILITY PERIOD

13.1 The "Defects Liability Period" for the entire work under the Contract shall be 365 days from

the date of completion mentioned in Completion Certificate.

- 13.2 If during the Defects Liability Period any portion of the Works is found defective or deficient in any manner and is repaired/rectified/replaced pursuant to the defects liability provisions of the Contract, the Defects Liability Period for such portion of the Works, shall, notwithstanding anything to contrary contained herein, be operative for a further period of 6 months from the date of such repair/rectification/ replacement but shall not in any case be operative for more than 18 months from the date of completion stated in the Completion Certificate.

14.0 Resolution of dispute

- i. In case of any dispute or differences out of the contract in connection with the contract, the same shall be referred to the Sole Arbitrator, who shall be appointed by the CEO, SAPDC. The award of the arbitrator shall be final and binding on both the parties.
- ii. The courts of Chainpur jurisdiction shall be exclusive jurisdiction to entertain any try of matter arising out of this contract.

SCOPE OF WORK

The detailed scope of work shall include but not be limited to the following:

- (i) Cutting and placing water supply pipes as per schedule of quantities.
- (ii) Construction of water tanks as per schedule of quantities, drawing and specification.
- (iii) Construction of steps as per schedule of quantities, drawing & specification.

SPECIAL CONDITIONS OF CONTRACT

- 1) The contractor shall make his own arrangement for material and equipment's transportation, loading, unloading, and electricity & water supply, required for the execution of work, at his own risk and cost.
- 2) The contractor shall make his own arrangement for construction of site stores, labour camps and site offices for which land shall also arranged by the contractor.
- 3) Contractor shall carry out the work as per the Nepal standard of work, technical specifications & drawings and as per directions of EIC.
- 4) All Items/materials are to be purchased as per list of approved materials/Items (if any) or/and as approved by EIC (if required).
- 5) No material and T&P will be issued by SAPDC.
- 6) The contractor has to deploy adequate labour and machinery where needed.
- 7) The contractor shall be responsible to ensure all safety measure during execution of work.
- 8) Contractor shall comply with all relevant quality, safety standards and all rules/ laws of Govt. of Nepal.
- 9) Unless otherwise specifically mentioned, all materials to be used, as per list of approved make, shall conform to Nepali Standard Specifications.
- 10) The work is to be done in smooth manner without hindrances to the works of other agencies, local people, surroundings and environments and as per the instructions of the Engineer-in-Charge.
- 11) Labour rules & conditions as circulated by the Central Govt./State Govt. from time to time shall be strictly observed by the Contractor and will abide the same.
- 12) **Clause 12 of GCC: - (Mile stone)**

S. No.	Mile stone	Time period from commencement date	Compensation for delay
1.	Completion of Work in all respect.	Four months	0.1% of Contract Price per day of delay subject to a maximum of 5% of Contract Price.

INSTRUCTIONS TO BE FOLLOWED FOR EXECUTION OF ALL KINDS OF BANK GUARANTEES

1. Bank Guarantee should be executed on papers of requisite value in accordance with the Stamp Act as applicable in Nepal.
2. The executing officers of the Bank Guarantee shall clearly indicate in (Block Letters), his name, designation, Power of Attorney No./Signing Power No. etc.
3. Each page of the Bank Guarantee shall be duly signed / initialed by the executing officers and the last page shall be signed in full, indicating the particulars as aforesaid (sub-para2) under the seal of the Bank.
4. The original Bank Guarantee should be sent by the Bank to SJVN Arun-3 Power Development Company Private limited directly under Regd. Post (A.D.). However, in exceptional cases, where the original BG is handed over to the bidder by the issuing bank/branch, the bidder shall ensure that an un-stamped duplicate copy of the BG has been sent immediately by the issuing bank/branch under Regd. Post (A.D.) directly to SJVN Arun-3 Power Development Company Private limited with a covering letter to compare with original BGs and confirm that it is in order.

1. FORM OF BANK GUARANTEE FOR EARNEST MONEY DEPOSIT

(Refer clause 14.0 of NIT & ITB)

WHEREAS _____ (Name of Bidder) (hereinafter called “the Bidder”) has submitted his bid dated _____ (date) for “Restoration of Amrang water Supply Scheme at Amrang Makalu RM-5 & restoration of Baripal-Mangtankha water supply scheme and Baripal-Mangtankha Foot Path.”

SEALED with the Common Seal of the said Bank this ____ day of _____ (Month and Year).

THE CONDITIONS of this obligation are:

1. If after Bid opening the Bidder withdraws his Bid during the period of bid validity specified in the Form of Bid or
2. If the Bidder having been notified of the acceptance of his Bid by the SJVN Arun-3 Power Development Company Private Limited, during the period of bid validity.
 - a. fails or refuses to execute the Form of Agreement in accordance with the Instructions to Bidders, if required; or
 - b. fails or refuses to furnish the Performance Security, in accordance with the Instructions to Bidders, or
 - c. does not accept the correction of the Bid Price pursuant to **Clause-24.0 of NIT & ITB.**
 - d. adopts corrupt or fraudulent practices

we undertake to pay to the SJVN Arun-3 Power Development Company Private Limited, the above amount upon receipt of its first written demand without the SJVN Arun-3 Power Development Company Private Limited having to substantiate its demand, provided that in its demand the SJVN Arun-3 Power Development Company Private Limited will note that the amount claimed by it due to it owing to the occurrence of one or any of the two conditions, specifying the occurred condition or conditions.

This Guarantee will remain in force up to and including the date 210 days after the deadline for submission of Bids as stated in the invitation to bid or as it may be extended by the SJVN Arun-3 Power Development Company Private Limited notice of which extensions(s) to the Bank is hereby waived. Any demand in respect of this Guarantee should reach the Bank not later than the above date.

DATE _____

SIGNATURE OF THE BANK _____

WITNESS _____

SEAL _____

(Signature, name and address)

2. FORM OF BANK GUARANTEE FOR PERFORMANCE SECURITY DEPOSIT
(Refer clause 29.0 of NIT & ITB)

Date:

To,
Name & Address of the Employer

We have been informed that (the "company"), having its registered office at has entered into a Agreement on (Insert LOA No. & Date)23.... with you for the work of "Restoration of Amrang water Supply Scheme at Amrang Makalu RM-5 & restoration of Baripal-Mangtankha water supply scheme and Baripal-Mangtankha Foot Path."

In accordance with the terms of the AGREEMENT, the Company is required to submit an unconditional and irrevocable, payable on-demand bank guarantee of NPR (Nepalese Rupees only), (the "**Security Amount**") to SAPDC for the due and faithful performance of the Company's obligations under the AGREEMENT (the "**Performance Security**") and we (name and address of the Bank, hereinafter called the "**Guarantor**") have at the request of the Company agreed to provide such Performance Security, being this Bank Guarantee (Performance Security) No.

On your first written demand, stating that (a) the Company is in default of its obligations under the AGREEMENT, or (b) the Company has not replaced this Performance Security with another performance security issued on the same terms at least fourteen (14) days prior to the Expiry Date (as hereinafter defined), we, the Guarantor as primary obligor hereby expressly, unconditionally and irrevocably undertake to pay to SAPDC, without demur, reservation, protest and any reference to the Company or the AGREEMENT the amount specified in such demand, provided that the total of all demands shall not exceed the sum of the Security Amount. You shall not be required to prove or show grounds for your demand or the sum specified therein. It is clarified further that your demand shall be conclusive evidence to us that such payment is due under the terms of the AGREEMENT. It shall not be necessary, and the Guarantor hereby waives any necessity, for SAPDC to proceed against the Company before presenting to the Guarantor its demand under the Performance Security.

The term of this Performance Security shall commence on the date of its issuance and shall expire on the date 45 days beyond the defect liability Period (the "**Expiry Date**").

All claims, if any, in respect of this Performance Security must be received by the Guarantor on or before the Expiry Date.

This guarantee is subject to Uniform Rules for Demand Guarantees ICC Publication No. 758, except that the provisions of Article 26 are hereby excluded and shall be governed by and construed in accordance with the Laws of Nepal and will be subject to the jurisdiction of the courts of Nepal.

The Performance Security shall not be affected by any change in the constitution of the Guarantor or of the Company.

Notwithstanding anything contained hereinabove:

- (1) Our liability under this Guarantee shall not exceed the Security Amount
- (2) Any demand may be brought by SAPDC under this Guarantee up to close of business on the Expiry Date.

(3) We shall be liable to pay any amount under this Guarantee or part thereof only if we receive a claim or demand in writing within banking hours at our branch on or before the Expiry Date and if no such demand has been received by us by that time and date, all rights to bring any demand under this guarantee will cease.

Notwithstanding sub-section (2) and (3) above, all claims made by SAPDC on or before the Expiry Date shall, subject to sub-section (1) above, be honoured by the Guarantor where payment in respect of such demands have not been made by the Expiry Date.

This guarantee (or any of its proceeds) is not assignable and is not transferable in whole or in part.

Upon payment by the Guarantor in respect of all claims or demands made by SAPDC under this Bank Guarantee on or before the Expiry Date, this guarantee automatically becomes null and void whether or not the original has been returned to us.

Signed for and on behalf of:

Name:

Designation:

Seal of the Bank:

Signed for and on behalf of:

[Note: delete the following signature block if not applicable]

[Signed for and on behalf of confirming bank in Nepal:.....]

Name:

Designation:

Seal of the Bank:

Signed for and on behalf of:]

PROFORMA FOR AGREEMENT

This agreement made this _____ day of _____
Between _____ (name and address of Employer) (hereinafter called
“SJVN Arun-3 Power Development Company”) and
_____ (name and address of
Contractor) (hereinafter called “the Contractor” of the other party).

Whereas the SJVN Arun-3 Power Development Company is desirous that the Contractor executes _____ (name and identification number of Contract) (hereinafter called ‘the Works’) and the SJVN Arun-3 Power Development Company has accepted the Bid by the Contractor for the execution and completion of such Works and the remedying of any defects herein at a contract price of NPRs. _____

NOW THIS AGREEMENT WITNESSETH as follow:

1. In this Agreement, words and expression shall assume the same meanings as are respectively assigned to them in the Conditions of Contract hereinafter referred to.
2. In consideration of the payments to be made by the SJVN Arun-3 Power Development Company to the Contractor as hereinafter mentioned, the Contractor hereby covenants with the SAPDC to execute and complete the Work and remedy the defects therein in conformity, in all aspects, with the provisions of the Contract.
3. The SJVN Arun-3 Power Development Company hereby covenants to pay the Contractor in consideration of the execution and completion of the Works and remedy the defects wherein the contract price or such other sum as may become payable under the provisions of the Contract at the times and in the manner prescribed by the Contract.
4. The following documents shall be deemed to form and be read and construed as part of this Agreement, Viz:
 - a. Agreement;
 - b. Letter of Acceptance;
 - c. Amendments;
 - d. Special Conditions of Contract;
 - e. General Conditions of Contract;
 - f. Detailed Scope of Work and Technical Specifications;
 - g. Priced Bill of Quantities;
 - h. Contractor’s Bid other than BOQ;
 - i. Tender drawings;
 - j. Notice Inviting Tender & Instructions to Bidders; and
 - j. Any other document forming part of the Contract.

The aforesaid document shall be taken as complementary and mutually explanatory of one another but in case of ambiguities or discrepancies, the precedence shall be taken in the order set out above.

In witness whereof the parties have caused this Agreement to be executed the day and year first before written.

For and on behalf of the Contractor

For and on behalf of SAPDC

Name: _____
(Authorized Signatory)

Name: _____

Designation: _____

Designation: _____

In the presence of:

In the presence of:

Name _____

Name _____

Add. _____

Add. _____

In witness whereof the parties have caused this Agreement to be executed the day and year first before written.

Signed and Delivered

Note: This Proforma is included in the Bidding Documents only for the information of the Bidders. Only the successful bidder, shall, in due course, be required to fill this Proforma.

Price Schedule/Bill of Quantities (BOQ)

Name of Work: PCD-236/2023 “Restoration of Amrang water Supply Scheme at Amrang Makalu RM-5 & restoration of Baripal-Mangtankha water supply scheme and Baripal-Mangtankha Foot Path.”

Sr. No.	Description of item	Unit	Qty	Rate (NPR inclusive of all taxes and duties including VAT)		Amount (NPR inclusive of all taxes and duties including VAT)
				In figures	In words	In figures
Part A: Restoration of Amrang watersupply Scheme at Amrang Makalu RM-3						
1.	Excavation for foundation and trenches by mechanical means through all types of soil (without blasting) including relevant lift and disposal upto 20m.	Cum	122.68			
2.	Providing and laying of hand pack Stone soling with 150 to 200 mm thick stones and packing with smaller stone on prepared surface as per Drawing and Technical Specifications.	Cum	2.19			
3.	Providing and placing Manually mixed non structural cement concrete 1:3:6(1 Cement :3 sand :6 graded stone aggregate 40 mm nominal size). including compaction, curing, testing and lead 30m. etc. all complete as per specification drawing and as directed by the Engineer.	Cum	1.72			
4.	Providing and laying Random rubble stone masonry in cement mortar 1:6 including scaffolding, curing, preparation of mortar etc. complete, mentioned height 0-5 lead 30m (machine mixing) mortar 30%.	Cum	4.83			
5.	Providing and laying, fitting and placing HYSD bar reinforcement complete as per drawing and technical specifications	Kg	464.72			

Sr. No.	Description of item	Unit	Qty	Rate (NPR inclusive of all taxes and duties including VAT)		Amount (NPR inclusive of all taxes and duties including VAT)
				In figures	In words	In figures
6.	Providing and placing machine mixed cement concrete of M20 grade for the Super structure, Deck slab, Girders etc. including compaction, curing, testing and lead 30m. etc. all complete as per specification and drawing.	Cum	2.92			
7.	Providing and applying 12.5mm thick cement plaster including mortar mixing scaffolding, curing etc. complete as per specification lead 30m (manual mixing) in cm 1:4.	Sqm	43.77			
8.	Providing and fixing HDPE pipe (PN-10) 32 mm including accessories complete as directed by engineer.	Rm	1220.00			
9.	Providing and fixing, erecting MS Angle 50x50x5mm vertical post "T" for anchoring at bottom and at top 25x25x3mm by welding for pipe supply all complete as per drawing and directed by Engineer In-charge.	Kg	94.58			
10.	Providing and fixing 1.8 meters high GI barbed wire fencing with 2.4 m angle iron posts 50 mm x 50 mm x 6 mm placed every 3 meters center to center founded in M 15 grade cement concrete, 0.6 meter below ground level, every 15th post, last but one end post and corner post shall be strutted on both sides and end post on one side only and provided with 12 horizontal lines and 2 diagonals interwoven with horizontal wires, fixed with GI staples, turn buckles etc. complete as per Drawing and Technical Specifications.	Rm	10.00			

Sr. No.	Description of item	Unit	Qty	Rate (NPR inclusive of all taxes and duties including VAT)		Amount (NPR inclusive of all taxes and duties including VAT)
				In figures	In words	In figures
Part B Restoration of Barpibal - Mangtankha water supply scheme and Barpibal - Mangtankha Foot path damage by construction of Arun-3 Powerhouse Access Road Chichila RM-3.						
11.	Excavation for foundation and trenches by mechanical means through all types of soil (without blasting) including relevant lift and disposal upto 20m.	Cum	122.12			
12.	Providing and laying of hand pack Stone soling with 150 to 200 mm thick stones and packing with smaller stone on prepared surface as per Drawing and Technical Specifications.	Cum	17.97			
13.	Providing and placing Manually mixed non structural cement concrete 1:3:6 (1 Cement :3 sand :6 graded stone aggregate 40 mm nominal size). including compaction, curing, testing and lead 30m. etc. all complete as per specification drawing and as directed by the Engineer.	Cum	9.21			
14.	Providing and laying Random rubble stone masonry in cement mortar 1:6 including scaffolding, curing, preparation of mortar etc. complete, mentiond height 0-5 lead 30m (machine mixing) mortar 30%.	Cum	31.8			
15.	Providing and laying, fitting and placing HYSD 10mm dia bar reinforcement complete as per drawing and technical specifications	Kg	192.18			
16.	Providing and placing machine mixed cement concrete of M20 grade for the Super structure, Deck slab, Girders etc. including compaction, curing, testing and lead 30m. etc. all complete as per specification and drawing.	Cum	1.44			

Sr. No.	Description of item	Unit	Qty	Rate (NPR inclusive of all taxes and duties including VAT)		Amount (NPR inclusive of all taxes and duties including VAT)
				In figures	In words	In figures
17.	Providing and applying 12.5mm thick cement plaster including mortar mixing scaffolding, curing etc. complete as per specification lead 30m (manual mixing) in cm 1:4	Sqm	136.67			
18.	Providing and fixing HDPE pipe (PN-10)32 mm dia. including accessories complete as directed by engineer.	Rm	385			
19.	Providing and fixing HDPE pipe (PN-10) 20 mm dia. including accessories complete as directed by engineer.	Rm	410			
20.	Providing and fixing of railing MS pipe 32mm dia @2.8kg/m ,4nos and 1500mm c/c spacing, vertical post including metal primer erecting by welding as per specification drawing and directed by Engineer.	Kg	600			
Total Amount (NPR) inclusive of all taxes and duties including VAT						
Discount, if any in percentage (%)						
Net Amount (NPR) after Discount						

Date:-

For and on behalf of the bidder

Place: -

**Signature of authorized representative of the Bidder,
along with his name, Seal of Company)**

TENDER DRAWINGS

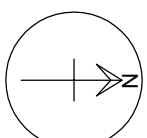

**SJVN Arun-3 POWER
DEVELOPMENT COMPANY**
ARUN-3 HYDRO ELECTRIC
PROJECT 900 MW

PROJECT NAME:

Gorkha Welfare Scheme
Aamrang , Makalu Ga.Pa.-5,
Sankhuwasava

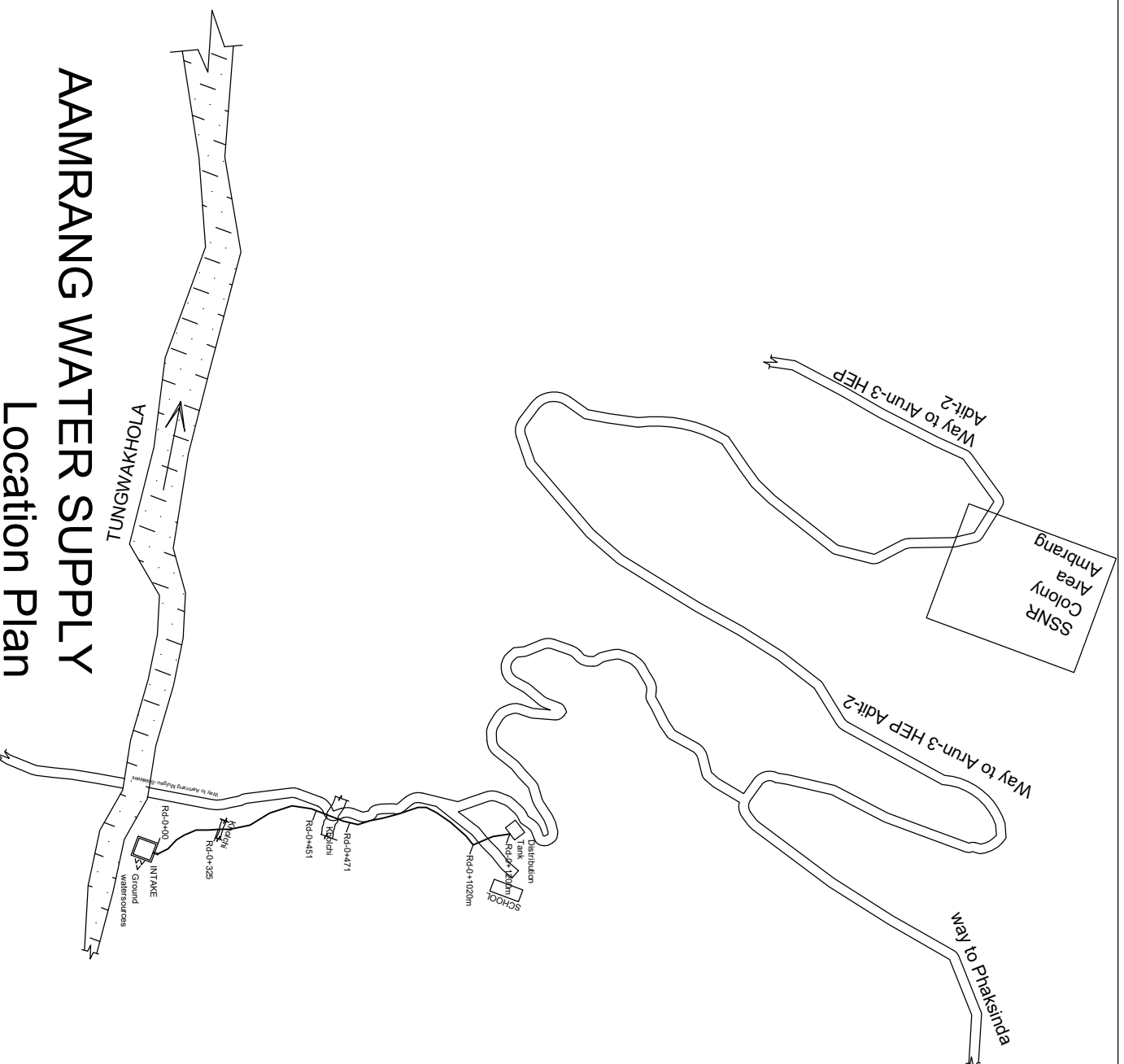

AAMRANG WATER SUPPLY Location Plan

SHEET NO: 1

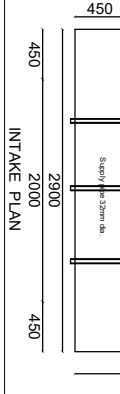
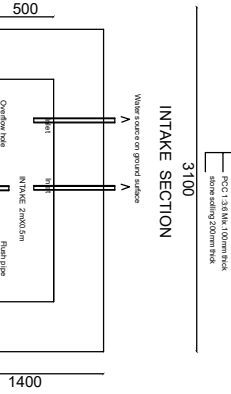
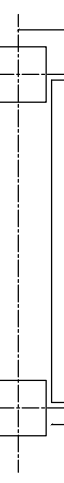
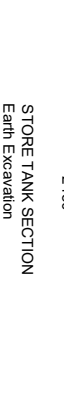
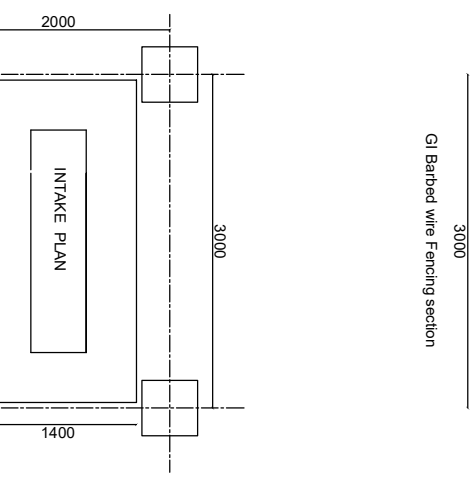
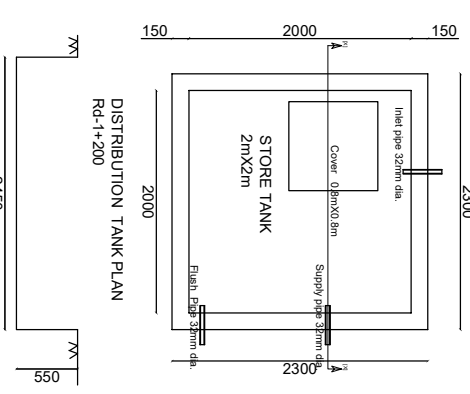
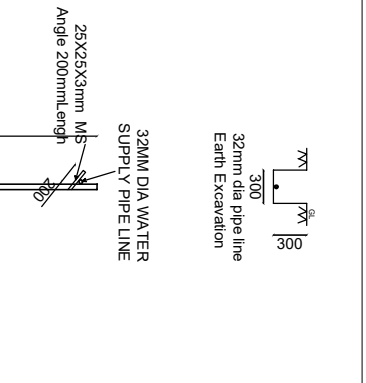
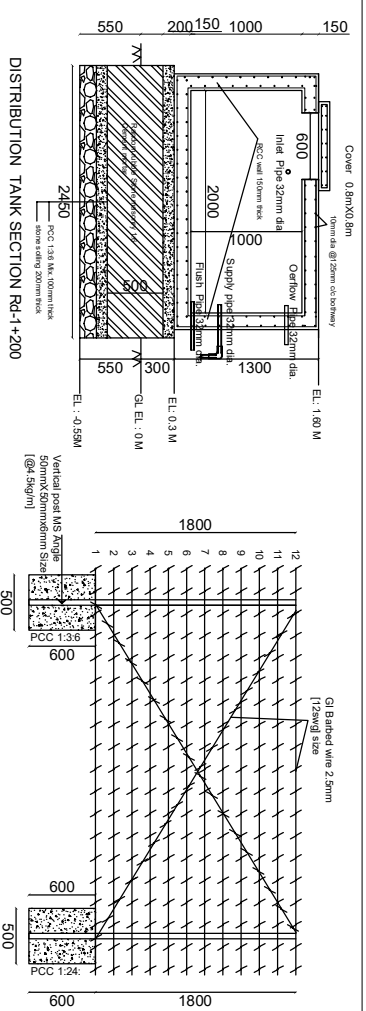

SJVN Arun-3 POWER DEVELOPMENT COMPANY
ARUN-3 HYDRO ELECTRIC PROJECT 900 MW

PROJECT NAME:
Gorkha Welfare Scheme
Aamrang , Makalu Ga.Pa.-5,
Sankhuwasava

SHEET NO: 2

**SJVN Arun-3 POWER
DEVELOPMENT COMPANY
ARUN-3 HYDRO ELECTRIC
PROJECT 900 MW**

**PROJECT NAME:
Barpipal -Mangtanka
Watersupply Scheme and
Barpipal -Mangtanka Foot steps
Chichila RM-3, Sankhuwasabha**

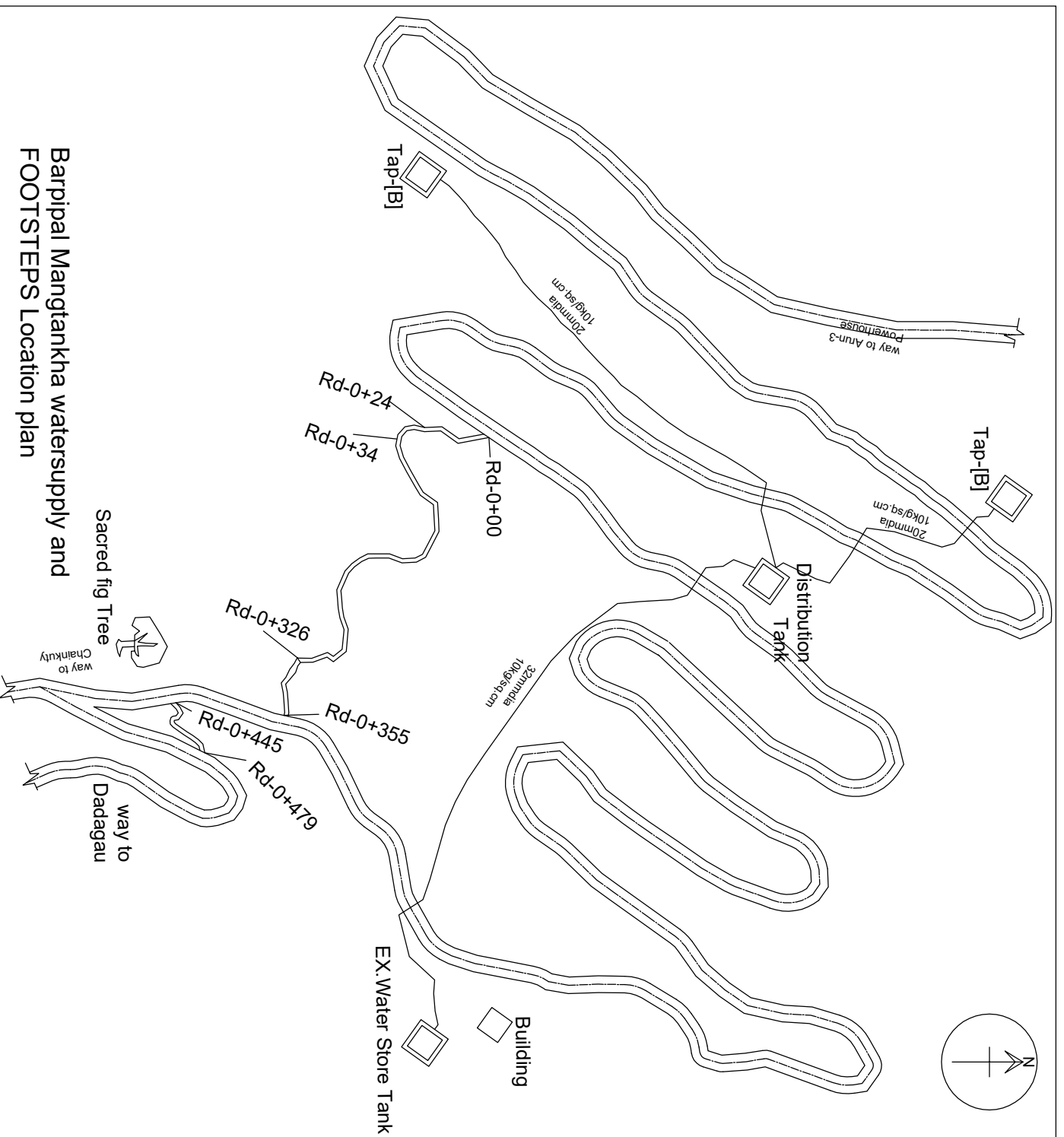

**Barpipal Mangtanka watersupply and
FOOTSTEPS Location plan**

SHEET NO: 1

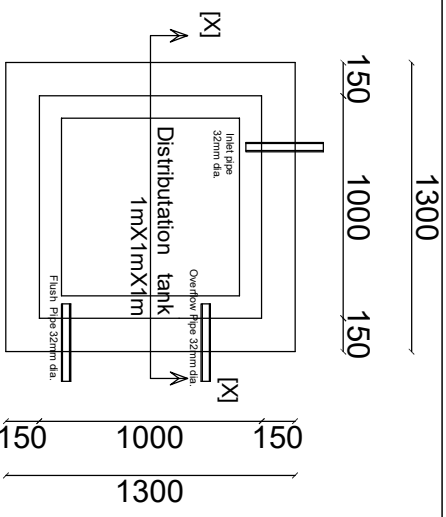

Distribution Tank plan

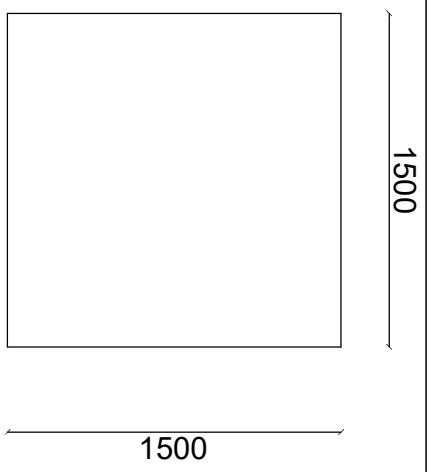

Distribution Tank Foundation plan

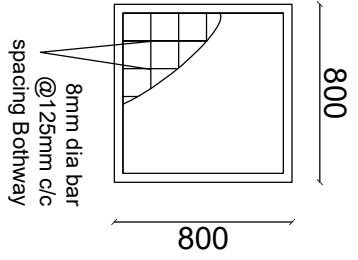

RCC Tank cover
0.8mx0.8mx0.15m

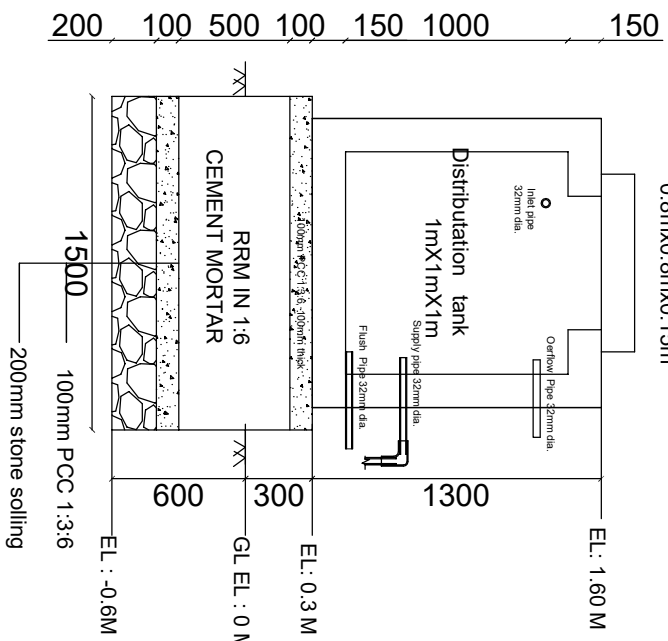

Distribution Tank Section at [X]-[X]

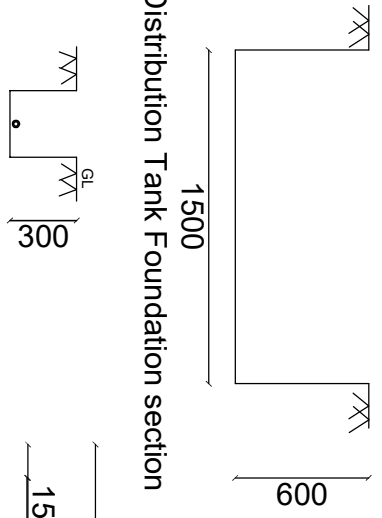

Distribution Tank Foundation section

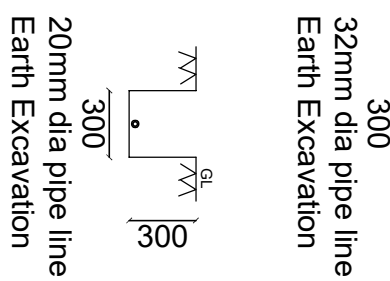

32mm dia pipe line
Earth Excavation

20mm dia pipe line
Earth Excavation

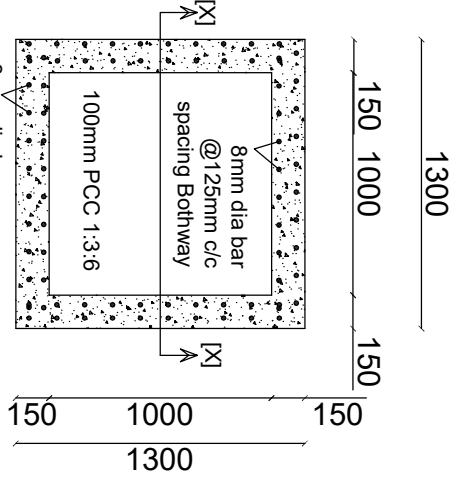

Distribution Tank Reinforcement Detail

**SJVN Arun-3 POWER
DEVELOPMENT COMPANY**
ARUN-3 HYDRO ELECTRIC
PROJECT 900 MW

PROJECT NAME:
Barpipal -Mangtankha
Watersupply Scheme Chichila
RM-3, Sankhuwasabha

SHEET NO: 2

**SJVN Arun-3 POWER
DEVELOPMENT COMPANY
ARUN-3 HYDRO ELECTRIC
PROJECT 900 MW**

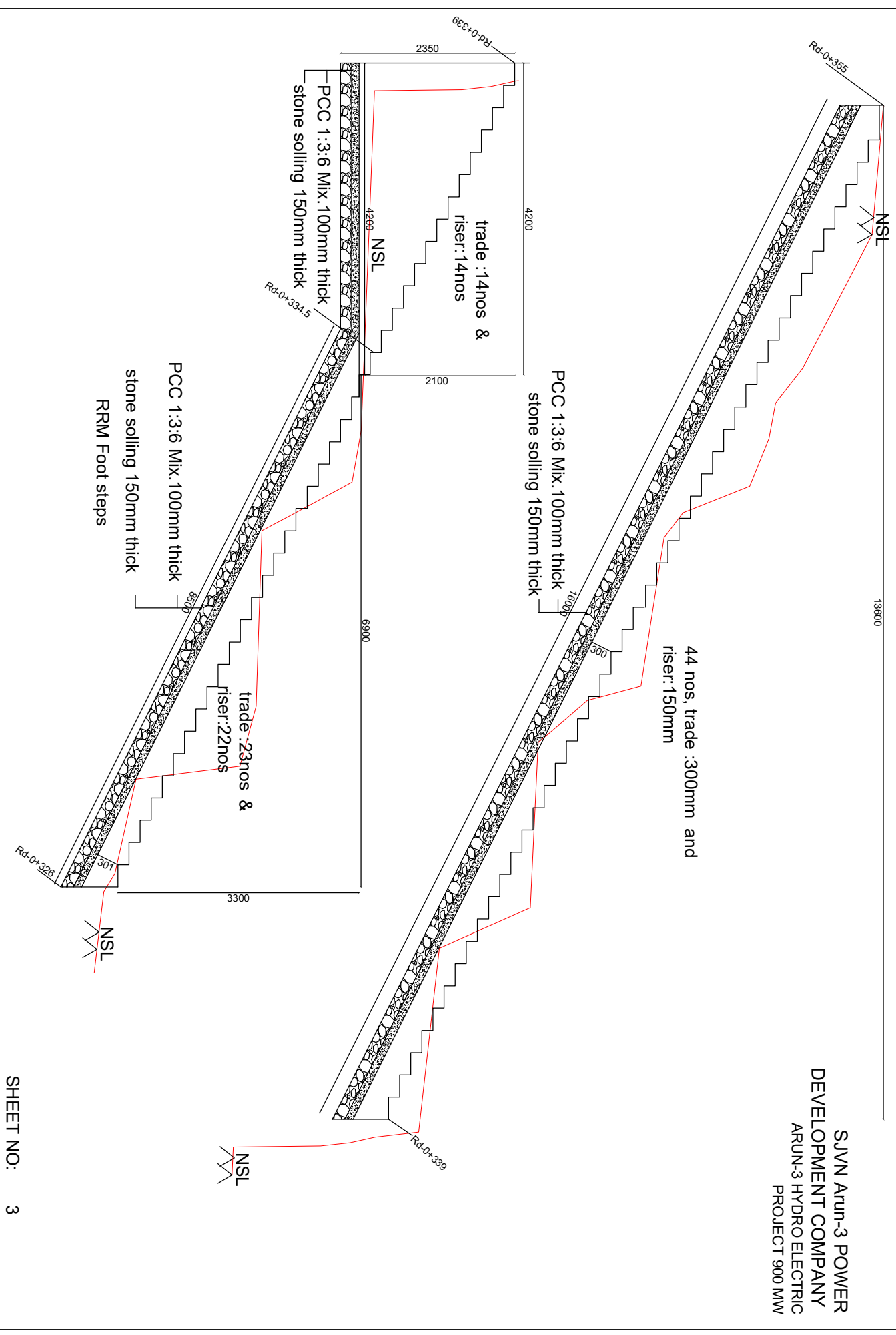

**SJVN Arun-3 POWER
DEVELOPMENT COMPANY
ARUN-3 HYDRO ELECTRIC
PROJECT 900 MW**

PROJECT NAME:
Barpail -Mangtanka
Watersupply Scheme Chichila
RM-3, S ankhwasabha

SHEET NO: 4

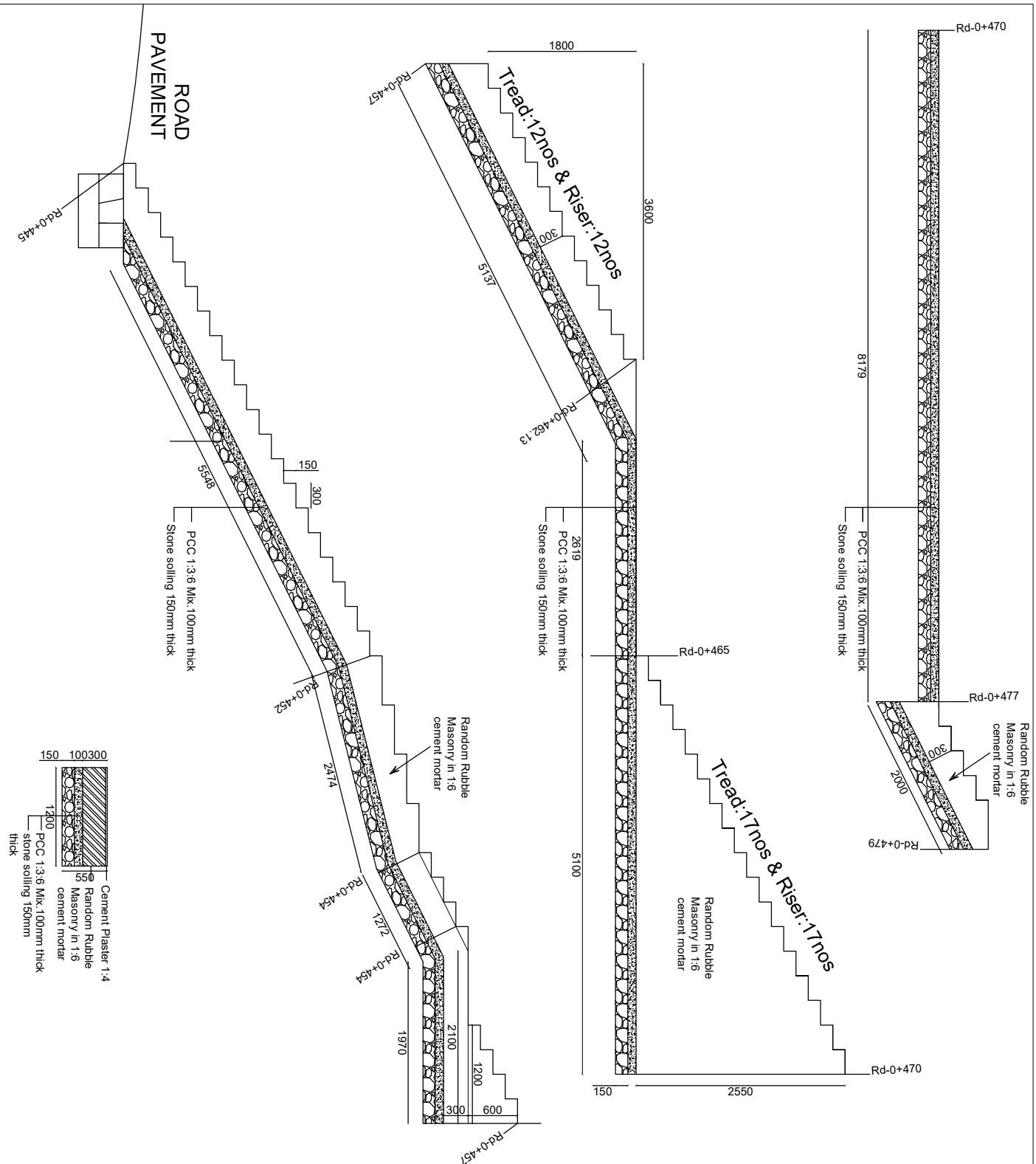

SJVN Arun-3 POWER
DEVELOPMENT COMPANY
ARUN-3 HYDRO ELECTRIC
PROJECT 900 MW

PROJECT NAME:

Construction of Footsteps
Barpail - Mangtankha,
Chichila Ga.Pa. -3,
Sankhuwasava

SHEET NO: 4

