

SJVN ARUN-3 POWER DEVELOPMENT COMPANY Pvt. Ltd.

(A Subsidiary of SJVN Ltd. Registered in Nepal)



Arun-3 HYDRO ELECTRIC PROJECT, NEPAL

TENDER DOCUMENT

[DOMESTIC COMPETITIVE BIDDING]

TENDER No.: PCD-212/2022

TENDER DOCUMENT FOR IMPROVEMENT OF KATWALDADA TO LUMBANG ROAD (RD 0.00 TO 1.479 KM), MAKALU RM-05, NUM, DISTT. SANKHUWASABHA, NEPAL UNDER LOCAL BENEFIT SHARING PLAN (LBSP) OF ARUN-3 HYDRO ELECTRIC PROJECT (900 MW).

Tumlingtar

January, 2022

TABLE OF CONTENTS

Section	Description
Section-I	Notice Inviting Tender (NIT)
Section-I-A	Project Profile and Scope of work and Specifications
Section-II	Instruction to Bidders (ITB)
Section-III	Tender form, Forms of Declaration and Undertaking, Qualification Information Forms and Schedules
Section-IV	General Conditions of Contract (GCC)
Section –V	Contract Forms
Section-VI	Special Conditions of the Contract (SCC)
Section- VII	Tender Drawings

SECTION-I

NOTICE INVITING TENDER

एसजेवीएन अरुण-3 पाँवर डवलपमेंट कंपनी प्रा. लि.
SJVN Arun-3 Power Development Company Pvt. Ltd.

(एसजेवीएन की पूर्ण स्वामित्व वाली अधीनस्थ कंपनी)

(A wholly owned subsidiary of SJVN)

900 मेगावाट अरुण-3 जलविद्युत परियोजना

900 MW Arun-3 Hydro Power Project

Regd. No.: 111808/69/070



Ref. No.: SAPDC/P&C/PCD-212/2022-24

Dated: 07.01.2022

NOTICE INVITING TENDER

1. SJVN Arun-3 Power Development Company (P) Ltd. (SAPDC), Tumlingtar, Nepal (A Subsidiary of SJVN, a joint venture of GoI & Govt. of H.P.) having Registered office at Kathmandu, Nepal invites sealed Item Rate bids in single stage two envelope bid system from the eligible Bidders from Nepal for the following work:

1.	Name of Work:	Improvement of Katwaldada to Lumbang Road (RD 0.00 to 1.479 km), Makalu RM-05, Num, Distt. Sankhuwasabha, Nepal under Local Benefit Sharing Plan (LBSP) of Arun-3 Hydro Electric Project (900 MW).
1.1	Tender No.	PCD-212/2022
1.2	Time Allowed for Completion of whole of the works	Total time for completion of work has been kept 6 (six) months to be reckoned from the 15 th day of issuance of Letter of Acceptance.
1.3	Estimated Cost	NPR 1,54,00,302/- including VAT.
1.4	Cost of Bidding Document (Non-refundable)	NPR 3,000/- in the form of Bank Draft/Manager's cheque payable at Khandbari, Nepal in favour of SJVN Arun-3 Power Development Company Pvt. Ltd.
1.5	<i>Deleted without change in Sr. No.</i>	<i>Deleted without change in Sr. No.</i>
1.6	Earnest Money Deposit	NPR 3,08,000/- only (to be submitted as per clause no. 14, Section-II, ITB).
1.7	Last date & time for submission of Bid(s).	30.01.2022 upto 1500 Hours.
1.8	Time and Date for opening of part-1 (Techno-commercial bid).	31.01.2022 at 1600 Hours.
1.9	Time and date of opening Financial Bid(s).	Shall be intimated later.
1.10	Bid validity period	180 days from the last date of submission of bids.
1.11	Place of submission/opening bids (As per Sr. No. 17.7 of ITB, Section-III)	Chief Engineer (P&C), SAPDC, Arun-3 HEP, Satluj Bhawan, Arun Sadan, Tumlingtar, Distt. Sankhuwasabha, Nepal Ph. +977-29-575154, Mob.: 9852058517, E-mail Address: pnc.sapdc@gmail.com

1.12	Authority/Officer inviting Tender	Chief Engineer (P&C), Arun-3 HEP, SAPDC, Satluj Bhawan, Arun Sadan, Tumlingtar, Distt. Sankhuwasabha, Nepal Ph. +977-29-575154, Mob.: 9852058517, E-mail Address: pnc.sapdc@gmail.com
------	-----------------------------------	-----------------------------------------------------------------------------------------------------------------------------------------------------------------------------------------------------------------------------------------------

2. The bidding document containing Instructions to Bidders, General Conditions of Contract, Special Conditions of Contract, Specifications, Drawings, Bill of Quantities etc. can be downloaded from websites <http://sjvn.nic.in/tender.htm> and <http://www.sapdc.com.np/pages/tender>. The bidders may submit their bid either by post/courier or physically in the tender box kept as per Sr. No. 1.11 herein-above prior to the last date for submission of bids. Bids of those Bidders who have submitted the requisite tender document fee and EMD acceptable to Employer only shall be considered for bid evaluation.

3. Eligibility

To qualify for award of the Contract each bidder should have;

- (a) Average Annual turnover during the last three Financial years, ending 15th July, 2021 should be at least i.e. **NPR 46,20,091/-**.

In support of above, Audit Reports and/or tax clearance certificate obtained from the Inland Revenue Department or documents showing submission of tax returns for the past three financial years shall be furnished by the Bidder.

- (b) Experience of Successfully Completion/substantial completion of Similar Works during last seven years (the end date of completion of work should fall within the preceding 7 years) ending last day of month previous to the one in which bids are invited as Contractor/ sub-contractor/ JV Member, at least amount either of following:-

One Similar Work costing not less than **NPR 1,23,20,242/- including VAT.**

Or

Two Similar Works each of costing not less than **NPR 77,00,151/- including VAT.**

Or

Three Similar Work each of costing not less than **NPR 61,60,121/- including VAT.**

Similar Work means “any civil work such as construction of building, road etc.”.

‘Substantial Completion’ here would mean completion of minimum 80% of awarded amount. In case work has been executed as JV, value of the work executed shall be considered in proportionate to percentage participation in JV.

Further, bidder who has completed/ Substantial Completed Similar Work which is part of awarded package is also eligible to bid subject to meeting other criterion mentioned here-in-above.

In support of above experience condition, the bidder shall submit copies of award letter/contract agreement along with successful completion certificate from the agency/firm for which work was executed. The bid shall be treated as non-responsive in case bidder fails to provide supporting document in respect of turnover and experience as detailed above.

- (c) **Bidder as Joint Venture/ Consortium are not eligible for Bidding.**

4. Each bidder must Submit:

- i. Photo copy of VAT/PAN and Company Registration;
 - ii. A declaration that the information furnished with the bid documents is correct in all respects in accordance with Form of Declaration provided in Section-III of the bidding documents.
 - iii. An undertaking to that effect that the bidder has read all the documents downloaded documents along with the NIT and there is no deviation from the standard terms and conditions of the bidding document & NIT etc. in accordance with Tender Form provided in Section-III of the bidding documents.
5. Even though the bidders meet the above qualifying criteria; they are subject to be disqualified if they have:
- (i) made misleading or false representations in the forms, statements, declarations and attachments submitted in proof of the qualification requirements; and/or
 - (ii) Record of poor performance such as abandoning the works, not properly completing the contract, inordinate delays in completion or financial failures etc.
 - (iii) Participated in the previous bidding for any civil work and had quoted abnormally high or low bid prices and could not furnish rational justification for it to the Employer.
6. Bidding document shall be available on website <http://sjvn.nic.in/tender.htm> and <http://www.sapdc.com.np/pages/tender>. At any time before the submission of bids, SJVN Arun-3 Power Development Company Private Limited may modify/ amend the Bidding document and extend the last date of submission/opening of the Bid and any other key dates by issuing a corrigendum/addendum and such corrigendum/addendum to this notice as well as to the Bidding document shall be available on the aforesaid websites only.
As such the Bidders are advised to visit the above websites regularly before deadline for submission of Bid.
7. Any Corrigendum /Addendum thus issued shall form part of bidding document and shall only be uploaded on <http://sjvn.nic.in/tender.htm> and <http://www.sapdc.com.np/pages/tender>.
8. To give prospective bidders reasonable time in which to take an addendum into account in preparing their bids, the Employer may extend, as necessary, the deadline for submission of bids.
9. Employer reserves the right to cancel the tendering process at any time without assigning any reason. SAPDC reserves the right to reject any or all the Bids without assigning any reason thereof.
10. For any enquiry/clarification etc. bidders may contact at the following address:

For & on the behalf of SAPDC

Sd/-

**Chief Engineer (P&C),
SAPDC, Arun-3 HEP,
Satluj Bhawan, Arun Sadan,
Tumlingtar, Distt. Sankhuwasabha, Nepal
Ph. +977-29-575154, Mob.:- 9852058517,
E-mail Address: pnc.sapdc@gmail.com**

SECTION-I-A

DETAILED SCOPE OF WORK AND TECHNICAL SPECIFICATIONS

DETAILED SCOPE OF WORK AND TECHNICAL SPECIFICATIONS

I. Scope of Work:

The detailed scope of work shall include but not be limited to the following:

- i) Road way excavation in all types of soil, ordinary rock and hard rock as per specifications and direction of the Engineer.
- ii) Executing other items of BOQ as per specification and direction of EIC.

II. Technical Specifications:

All the civil works shall be executed and complying to the relevant standard specifications of Govt. of Nepal (i.e. used by DOR, Nepal).

III. List of Approved Makes:

Unless otherwise specifically mentioned all materials to be used shall conform to Nepal Standards/codes or/and as approved by EIC.

Sr. No.	Items	Approved Make
1.0 List of Approved Makes for Civil Works:		
1.	TOR STEEL	AARTI, JAGDAMBA, SHAKHA, HULAS, AMBE
2.	CEMENT (OPC 53 Grade).	JAGDAMBA, ALGAKHANCHI, MARUTI, NIGALE, ULTRA

SECTION –II

**INSTRUCTIONS TO BIDDERS
(ITB)**

INSTRUCTIONS TO BIDDERS (ITB)

A. General

1. Scope of Bid

- 1.1 The SJVN Arun-3 Power Development Company Private Ltd. hereinafter referred to as SAPDC or the Owner or the Employer invites bids for the construction of Works, as described in these documents and referred to as “the Works”. The name and identification number of the works is as provided in the NIT.
- 1.2 The successful Bidder will be required to complete the Works in the Time allowed for Completion specified in the **Schedule B** in accordance with Conditions of Contract.
- 1.3 Throughout these documents, the terms “bid” and “tender” and their derivatives (bidder/tenderer, bid/ tender, bidding/ tendering, etc.) are synonymous.
- 1.4 Bids will be open for Nepalese bidders only.

2. Eligible Bidders

This Invitation for Bid is open to all eligible bidders meeting the eligibility criteria as defined in Clause 3.2 here-in-below.

- 2.1 Bidders should not be under a declaration of ineligibility for corrupt and fraudulent practices by the Central Government, the State Government or any public undertaking, autonomous body, authority by whatever name called under the Central or the State Governments (India/Nepal) on date of submission of Bid.

3. Qualification of the Bidder

- 3.1 All bidders shall include the following information and documents with their bids in Qualification Information:

- a) Tender Form;
- b) Forms of declaration and undertakings;
- c) Qualification requirements details **Form A** - Average Annual Turnover;
- d) Qualification requirements details **Form B** - Construction Experience;
- e) Photo copy of VAT/PAN and Company Registration;
- f) Power of Attorney in favour of authorized signatory;
- g) Schedules B and F (Integrity Pact);
- h) *Deleted without change in Sr. No.*

- 3.2 To qualify for award of the Contract each bidder should have;

- (a) Average Annual turnover during the last three Financial years, ending 15th July, 2021 should be at least i.e. **NPR 46,20,091/-**.

In support of above, Audit Reports and/or tax clearance certificate obtained from the Inland Revenue Department or documents showing submission of tax returns for the past three financial years shall be furnished by the Bidder.

- (b) Experience of Successfully Completion/substantial completion of Similar Works during last seven years (the end date of completion of work should fall within the preceding 7 years) ending last day of month previous to the one in which bids are invited as Contractor/ sub-contractor/ JV Member, at least amount either of following:-

One Similar Work costing not less than **NPR 1,23,20,242/- including VAT.**

Or

Two Similar Works each of costing not less than **NPR 77,00,151/- including VAT.**

Or

Three Similar Work each of costing not less than NPR **61,60,121/- including VAT.**

Similar Work means “any civil work such as construction of building, road etc.”.

‘Substantial Completion’ here would mean completion of minimum 80% of awarded amount. In case work has been executed as JV, value of the work executed shall be considered in proportionate to percentage participation in JV.

Further, bidder who has completed/ Substantial Completed Similar Work which is part of awarded package is also eligible to bid subject to meeting other criterion mentioned here-in-above.

In support of above experience condition, the bidder shall submit copies of award letter/contract agreement along with successful completion certificate from the agency/firm for which work was executed. The bid shall be treated as non-responsive in case bidder fails to provide supporting document in respect of turnover and experience as detailed above.

(c) Bidder as Joint Venture/ Consortium are not eligible for Bidding.

3.3 Even though the bidders meet the above qualifying criteria, they are subject to be disqualified if they have:

- (i) made misleading or false representations in the forms, statements, declarations and attachments submitted in proof of the qualification requirements; and/or
- (ii) Record of poor performance such as abandoning the works, not properly completing the contract, inordinate delays in completion or financial failures etc.
- (iii) Participated in the previous bidding for any civil work and had quoted abnormally high or low bid prices and could not furnish rational justification for it to the Employer.

4. Cost of Bidding

The bidder shall bear all costs associated with the preparation and submission of his bid and SAPDC will in no case be responsible or liable for these costs, regardless of the conduct or outcome of the bidding process.

5. Site Visit

5.1 The Bidders, in their own interest and at their expense, should inspect and examine the site and its surroundings and satisfy themselves, before submitting their tender, in respect of the site conditions including but not restricted to the following which may influence or affect the work or cost thereof under the Contract:

- a) Site conditions including access to the site, existing and required roads and other means of transport/ communication for use by them in connection with the works;
- b) Requirement and availability of land and other facilities for their enabling works, colonies, stores and workshops etc.;
- c) Ground conditions including those bearing upon transportation, disposal, handling and storage of materials required for the work or obtained therefrom;
- d) Source and extent of availability of suitable materials including water, etc. and labour (skilled and un-skilled), required for work and Laws and Regulations governing their use and employment;
- e) Geological, meteorological, topographical and other general features of the site and its surroundings as are pertaining to and needed for the performance of the work;
- f) The limit and extent of surface and sub-surface water to be encountered during the performance of the work and the requirement of drainage and pumping;

- g) The type of equipment and facilities needed, preliminary to, for and in the performance of the work; and
- h) All other information pertaining to and needed for the work including information as to the risks, contingencies and other circumstances which may influence or affect the work or the cost thereof under this contract.

5.2 The Bidders should note that information, if any, in regard to the site and local conditions, in these Bidding Documents, except for the material agreed to be supplied by the Employer, has been given merely to assist the Bidders and is not warranted to be complete.

5.3 The Bidders should note and bear in mind that the Employer shall bear no responsibility for the lack of acquaintance of the site and other conditions or any information relating thereto, on their part. The consequences of the lack of any knowledge, as aforesaid, on the part of the Bidders shall be at their risk and cost and no charges or claims whatsoever consequent upon the lack of any information, knowledge or understanding shall be entertained or payable by the Employer.

B. Bidding Documents

6.0 Content of Bidding Documents

6.1 The set of bidding documents comprises the documents listed below and addendum issued in accordance with Clause 8 of ITB.

Section-I	Notice Inviting Tender (NIT)
Section-I-A	Detailed Scope of Work and Specifications
Section-II	Instructions to Bidders (ITB)
Section-III	Tender form, forms of Declaration and Undertakings, Qualification Information Forms and Schedules
Section-IV	General Conditions of Contract (GCC)
Section-V	Contract Forms
Section-VI	Special Conditions of Contract (SCC)
Section-VII	Tender Drawings

6.2 The bidder is expected to examine carefully all instructions, Forms, Bill of Quantities, qualification information and other schedules, General and Special conditions of contract, specifications, and drawings in the Bid Document. Failure to comply with the requirements of Bid Documents shall be at the bidder's own risk. Pursuant to clause 23 and 24 hereof, bids which are not substantially responsive to the requirements of the Bid Documents, shall be rejected. However, after study of the documents if the bidder notices any error in typing, spellings and/or any omission the same can be brought to the notice of Employer at least 7 days prior to the deadline for submission of bids. It shall be the sole discretion of the Employer to consider such errors/omissions for which necessary corrigendum will be issued.

7.0 Clarification of Bidding Documents

A prospective bidder requiring any clarification of the bidding documents may notify in writing through post/email on address/email ID provided in NIT.

8.0 Amendment of Bidding Documents

8.1 At any time prior to the deadline for submission of bids, the SAPDC may amend the Bidding Documents by the issuance of an addendum/corrigendum.

8.2 In case of any amendment/corrigendum to this Tender Notice as well as to the Tender Document, such corrigendum/addendum to the Bidding document shall be available on the websites <http://sjvn.nic.in/tender.htm> and <http://www.sapdc.com.np/pages/tender> only.

8.3 Any Corrigendum /Addendum thus issued shall form part of bidding document and shall only be uploaded on <http://sjvn.nic.in/tender.htm> and <http://www.sapdc.com.np/pages/tender>.

8.4 In order to afford prospective bidders reasonable time in which to take an addendum into account for preparing their bids, the SAPDC may, at its discretion extend, as necessary, the deadline for submission of bids in accordance with Para-18 hereof.

C. Preparation of Bids

9.0 Language of Bids

The bid prepared by the bidder and all correspondence and documents thereto exchanged by the bidder and the SAPDC be written in English language. Supporting documents and printed literature furnished by the bidder with the bid may be in another language provided these are accompanied by an appropriate translation of pertinent passages in the above stated language. For the purpose of interpretation of the bid, English language shall prevail.

10.0 Documents Comprising the Bid

10.1 The Bid submitted by the bidder shall comprise the following documents:

- a) Envelope-1: EMD and cost of bid document along with Techno-commercial bid, and
- b) Envelope-2: Price Bid.

10.2 The Bidder shall treat the Bidding Documents and contents thereof as confidential.

11.0 Bid Prices

11.1 Unless stated otherwise in the Bidding Documents, the Contract shall be for the whole Works as described in the Bidding Documents based on Priced Schedule/Bill of Quantity submitted by the bidder.

11.2 The bidder shall offer rates & prices in the Priced Schedule/Bill of Quantities of the Bidding documents. The quoted rates shall be inclusive of all taxes and duties including VAT and SAPDC shall not bear anything extra on this account.

11.3 The rates and amounts shall be quoted in decimal in such a manner that no interpolation is possible. The rates and amounts shall be written both in words and figures. Corrections, if any, shall be made by crossing out, initialing, dating and rewriting. Corrections by applying correcting fluid shall not be permitted.

11.4 The bidder shall fill in unit rates and prices for all items of Works described in the Bill of Quantities/Priced Schedule. Items against which no rate or price is entered by the bidder will not be paid for by the SAPDC when executed, and shall be deemed to be covered by the other rates and prices in the Bill of Quantities/Priced Schedule. However, the rate for excess over quantities of such items beyond deviation limit prescribed under the contract will be worked out in accordance with the provisions contained in the Contract.

11.5 Only unconditional discount offered in the BOQ shall be considered for evaluation.

12.0 Currencies of Bid and Payment

The unit rates and prices shall be quoted by the bidder entirely in Nepalese Rupees (NPR) and payment shall be made in Nepalese Rupees (NPR) only.

13.0 Bid Validity Period

13.1 Bids shall remain valid for acceptance for a period of 180 days (one hundred eighty days) from the last date of submission of bids.

13.2 SAPDC may request the bidders to extend the period of validity for a specified additional period. The request and the bidder's response shall be made in writing. A bidder may refuse the request without forfeiting his bid security. A bidder agreeing to the request will not be permitted

to modify his bid, but will be required to extend the validity of his bid security for the period of the extension and in compliance with Para-14.0 hereof in all respects.

14.0 Bid Security/EMD

- 14.1 Earnest Money shall be submitted in the shape of Bank Draft/Manager Cheque/FDR (duly pledged in favour of SAPDC)/ Bank Guarantee in favor of SJVN Arun-3 Power Development Company Pvt. Ltd. payable at Khandbari for an amount as mentioned at para 1.6 herein-above. Bank Guarantee may be in the format provided in tender document.
- 14.2 Any bid not accompanied by an acceptable Earnest Money Deposit shall be rejected by the Employer as non-responsive.
- 14.3 The Earnest Money of unsuccessful bidders will be returned within 28 days of issuance of Letter of Acceptance.
- 14.5 The Earnest Money of the successful Bidder will be discharged within 28 days after the Bidder has signed the Agreement and furnished the required Performance Security Deposit.
- 14.6 The Earnest Money may be forfeited:
- a) if the Bidder withdraws the Bid after bid opening (technical bid) during the period of Bid validity;
- Or**
- b) if the bidder does not accept the correction of bid price pursuant to clause 24 of ITB.
- Or**
- c) if the Bidder adopts corrupt or fraudulent practices
- Or**
- d) in the case of a successful Bidder, if the Bidder fails within the specified time limit to
 - i. sign the Agreement; and/or
 - ii. furnish the required Performance Security Deposit.
- 14.7 The Bank Guarantee against Earnest Money shall remain valid for 30 days beyond the period of validity of bid i.e. total 210 days from the last date of submission of bids.
- 14.8 No interest shall be paid by SAPDC on Earnest Money Deposit.

15.0 Variation in Bidding Conditions

Bidder shall submit offers which comply fully with the requirements of the Bidding Documents. Bids which take deviations from the conditions of the contract will not be considered.

16.0 Signing of bid

- 16.1 The original bid shall be typed or written in indelible ink and shall be signed by a person or persons duly authorized to sign on behalf of the bidder under legally enforceable Power of Attorney. All the pages of the bid shall be signed and stamped at the lower right hand corner by the person or persons signing the bid.
- 16.2 The bid shall not contain any alterations or additions or deletions except those to comply with the instructions issued by the Employer or as necessary to correct errors made by the bidder in which case, such corrections shall be initialed by the person or persons signing the bid.
- 16.3 The Bid should be signed by legally authorized signatory only.
- a) If the tender is **submitted by an individual**, it shall be signed by the proprietor above his full name and name of the firm with its current business address.
 - b) If the tender is submitted **by a proprietary firm**, it shall be signed by the proprietor above his

- full name and full name of the firm with its current business address.
- c) If the tender is submitted by a **firm in partnership**, it shall be signed by a partner holding the power of attorney for the firm for signing the tender, in which case a certified copy of the power of attorney shall accompany the tender. A certified copy of the partnership deed duly registered and current business address of all the partners of the firm shall also accompany the tender.
 - d) If the tender is submitted by a **limited company** or a **limited corporation**, it shall be signed by a duly authorized person holding the power of attorney or any other legally valid document for signing the tender, in which case a certified copy of the power of attorney or any such legally valid document shall accompany the tender.
 - e) All witnesses shall be persons of status and their full names, occupations and addresses shall be stated below their signatures.

D. Submission of Bids

17.0 Documents comprising the bid and manner of Submission thereof:

17.1 The bid shall consist of two parts as under:

Part –I

- i) Bid Security/EMD and Cost of Tender Document
- ii) Comprising Techno-commercial bid (**excluding price bid**). The following documents duly signed and stamped shall be submitted in this part of the bid:
 - a) Tender Form;
 - b) Forms of declarations and undertakings;
 - c) Qualification requirements details **Form A** - Average Annual Turnover;
 - d) Qualification requirements details **Form B** - Construction Experience;
 - e) Photo copy of VAT/PAN and Company Registration;
 - f) Power of Attorney in favour of authorized signatory;
 - g) Schedules B and F (Integrity Pact)
 - h) *Deleted without change in Sr. No.*

The bidder shall also fill, sign and stamp each page of the documents forming part of the bid, on the left hand cover (bottom side).

17.2 Part-II Comprising of Price Bid at Schedule-A i.e., duly filled price schedule/ Bill of Quantities (BOQ). Discounts offered, if any shall be provided under Schedule-A only.

17.3 The bidder shall not give any indication about the bid price in any manner whatsoever in the “Techno-Commercial” part of the bid. Non-compliance of this provision shall result in the rejection of bid.

17.4 The part II of the bid (i.e. Price bid) shall be strictly in accordance with the forms provided in the Bill of Quantities /Price Schedule.

17.5 The bidder shall not take any deviation from the bid conditions.

17.6 The Part – I & Part-II of the bids shall be packed and submitted in the following manner.

- i. Part –I & Part- II of the bids shall be kept in separate covers duly super scribed with the “Part – I- Bid Security, Cost of Tender Document and Techno Commercial Bid” and ‘Part-II- Price Bid’ and sealed.
- ii. The Part-I of the bid shall then be kept in one single cover and sealed duly super scribed “Bid security and cost of Tender Document and Techno Commercial Bid. “Similarly, original Part-II of the bid shall then be kept in one single cover and sealed duly super scribed “Part-II – Price Bid”.

- iii. The two separate covers containing Part-I & Part –II of the bid shall then be kept in a cover and sealed. The outer most cover would bear the following identifications:

On upper left hand corner.

- ◆ Bid for (Name of Work)
- ◆ Do not open before *{Insert Last Date & Time of Bid Submission}*
- ◆ To be opened by tender committee only.

In the center of the cover.

- ◆ Name of the person/ officer and the office address to whom bid is addressed.

On the bottom left hand corner:

- ◆ Name and address of the bidder.

- 17.7 The bidders must submit their bid either by post/courier or physically in the tender box kept at the address as mentioned in NIT prior to the last date for submission of bids. SAPDC shall not be responsible for any delay in receipt due to any reason whatsoever and/ or for loss of the bid in postal transit.

18.0 Dead line for Submission of Bids

- 18.1 The bids shall be received by SAPDC not later than the time & date at the address specified at Para 1.7 & 1.11 of Section-I (NIT).
- 18.2 SAPDC may extend the deadline for submission of bids by issuing an amendment in accordance with Para 8.0 hereof, in which case all rights and obligations of the SAPDC and the bidders previously subject to the original deadline will then be subject to the new deadline.

19.0 Late/Delayed Bids

Any bid received by the SAPDC after the deadline prescribed by the SAPDC in accordance with Para-18.0 hereof will be returned un-opened to the bidder.

20.0 Modification and Withdrawal of Bids

- 20.1 The bidder may modify or withdraw his bid after bid submission, provided that the modification or notice of withdrawal is received in writing by the SAPDC prior to the prescribed deadline for submission of bids.
- 20.2 The bidder's modification or notice of withdrawal shall be prepared, sealed, marked and delivered in accordance with the Para-16.0 & 17.0 hereof, with the inner envelopes additionally marked "Modification" or "Withdrawal" as appropriate.
- 20.3 No bid may be modified subsequent to the deadline for submission of bids.

E. Bid Opening and Evaluation Procedure

21.0 Bid Opening

- 21.1 Bids for which an acceptable notice of withdrawal has been submitted pursuant to Para-20.0 hereof shall not be opened.
- 21.2 Then, the Part-I of the bid i.e., the envelope containing bid security & cost of tender document and the document as per 17.1 of ITB shall be opened. The bids whose bid security/ cost of tender document is either deficient in value and/ or form, will be rejected out rightly & will not be evaluated further.

21.3 The "Price Bid" (Part-II of the bid) shall be opened at a subsequent date for which a separate intimation will be sent. It will be discretion of the SAPDC to invite all the bidders to be present at the time of opening of price bids or only those bidders whose bids are ascertained to be techno-commercially responsive. The envelope of modification pursuant to Para-20 hereof, if any, to this part of bid shall be opened first.

21.4 Bidder's authorized representatives may attend the bid opening. The officers of the SAPDC authorized for opening of bids will announce the bidder's name, written notifications of bid withdrawal if any, the presence or absence of the requisite bid security, the deviations taken by the bidder's etc., and any such detail as the said officer(s) may consider appropriate. The bidder's representative(s) shall sign register provided by SAPDC for evidencing their participation in the process of bid opening.

22.0 Clarification of Bids

To assist in the examination, evaluation and comparison of bids, SAPDC may ask bidders individually for clarification of their bids. The request for clarification and the response shall be in writing or by email, but no change in the price or substance of the bid shall be sought, offered or permitted except as required to confirm the correction of arithmetic errors discovered by SAPDC during the evaluation of the bids in accordance with sub-Para-24.1 hereof.

23.0 Determination of Responsiveness & Techno-Commercial evaluation

23.1 Prior to the detailed evaluation of bids, the SAPDC will determine whether each bid:

- i) meets the eligibility and qualification requirements set out under Para 2.0 & 3.0 hereof ;
- ii) has been properly signed.
- iii) is accompanied by the required securities, and
- iv) is substantially responsive to the requirements of the bidding documents.

23.2 A substantially responsive bid is one, which conforms to all the terms, conditions and specifications of the Bidding Documents without material deviation or reservation. A material deviation or reservation is one:

- i) which affects in any substantial way the scope, quality or performance of the Works;
- ii) which limits in any substantial way, inconsistent with the Bidding documents, the SAPDC rights or the bidder's obligations under the Contract; or
- iii) whose rectification would affect unfairly the competitive position of other bidders presenting substantially responsive bids.

23.3 If a bid is not substantially responsive, it will be rejected by the SAPDC and may not subsequently be made responsive by correction or withdrawal of the non-conforming deviation or reservation or by submission of subsequent clarifications.

24.0 Commercial evaluation

24.1 Bids determined to be substantially responsive will be checked by the SAPDC for any arithmetic errors. Errors will be corrected by SAPDC as follows:

- i) where there is a discrepancy between unit rate in figures and in words, the unit rate in words will govern; and
- ii) where there is a discrepancy between the unit rate and the line item total resulting from multiplying the unit rate by the quantity, the unit rate as quoted in words will govern.
- iii) in case error due to wrong extension of quantities the quantities as specified in the Bid documents will be considered and multiplied by the unit rates quoted in words to obtain the amount.

24.2 The amount stated in the Bid will be adjusted by the SAPDC in accordance with the above procedure for the correction of errors and shall be considered as binding upon the bidder. If the bidder does not accept the corrected amount of bid, his bid will be rejected and the bid security shall be forfeited.

24.3 Evaluation and Comparison of Bids

24.3.1 SAPDC will evaluate and compare only the bids determined to be substantially responsive to the requirements of the Bidding Documents in accordance with Para-23.0 hereof.

24.3.2 In evaluating bids, SAPDC will determine, for each bid, the Evaluated Bid Price by adjusting the bid price as follows:

- i) Making any correction for errors pursuant to sub-Para-24.1 hereof;
- ii) Making an appropriate adjustment to reflect discounts in accordance with Para-11.5 hereof.

24.3.3 In case bids are invited on Item Rate Method and if the bid of the successful bidder is seriously unbalanced in relation to the Engineer's estimate of the cost of work to be performed under the contract, the Employer may require the Bidder to produce detailed price analyses for any or all items of the Bill of Quantities, to demonstrate the internal consistency of those prices with the construction methods and schedule proposed. After evaluation of the price analyses, the Employer may require that the amount of the performance security set forth in Clause 29 of ITB be increased at the expense of the successful Bidder to a level sufficient to protect the Employer against financial loss in the event of default of the successful Bidder under the Contract. The amount of the increased performance security shall be decided at the sole discretion of the Employer, which shall be final, binding and conclusive on the bidder.

F. Award of Contract

25.0 Award Criteria

Subject to Para-23.0 hereof, SAPDC will award the contract to the bidder whose bid has been determined to be substantially responsive to the Bidding documents and who has offered the lowest evaluated bid price pursuant to Para-24.0 hereof provided the evaluated Bid Price is within a reasonable variation of the estimated amount of Work.

26.0 Right to accept any Bid and to reject any or All Bids

Notwithstanding Para-25.0, the SAPDC reserves the right to accept or reject any bid or to annul the bidding process and reject all bids, at any time, without thereby incurring any liability to the affected bidder or bidders or any obligation to inform the affected bidder or bidders of the grounds for the SAPDC action.

27.0 Notification of Award

27.1 Prior to the expiration of the period of bid validity prescribed by the SAPDC or any extension thereof, the SAPDC will notify the successful bidder in writing that his bid has been accepted. This letter (hereinafter and in the Conditions of Contract called "Letter of Acceptance") shall name the sum which the SAPDC will pay to the Contractor in consideration of the execution, completion and maintenance of the Works by the Contractor as prescribed by the Contract (hereinafter and in the Conditions of Contract called "the Contract Price").

27.2 The notification of award will constitute the formation of the Contract.

28.0 Signing of Agreement

- 28.1 Within thirty (30) days of issue of the Letter of Acceptance, on a date and time mutually agreed upon, the successful bidder or his authorized representative shall attend the Office of tender inviting authority for signing of the Agreement.
- 28.2 Failure on the part of the successful bidder to comply with the requirements of this para shall constitute sufficient grounds for the annulment of the award and forfeiture of the bid security.

29.0 Performance Security Deposit

- 29.1 Within 30 (thirty) days from the date of issue of the Letter of Acceptance, the successful bidder shall deliver to the Employer a Performance Security equal to **5% (Five percent)** of the Contract Price, plus additional security for unbalanced bids in accordance with Clauses 24.3 of ITB 24.3.3 and Clause 3 of General Conditions of Contract valid till 45 days beyond Defect Liability Period.
- 29.2 The Performance Security Deposit shall be in the form of a demand draft / FDR / Banker Cheque issued by a Class A bank situated in Nepal acceptable to SJVN Arun-3 Power Development Company Private Limited. The bidder may also submit the same in the form of irrevocable, valid and fully enforceable Bank Guarantee in favour of SJVN Arun-3 Power Development Company Private Limited in the prescribed form from a Class A bank situated in Nepal acceptable to SJVN Arun-3 Power Development Company Private Limited which shall be valid till **45 (Forty five) days beyond Defect Liability Period.**
- 29.3 Failure of the successful Bidder to comply with the requirements of Clause 29.1 shall constitute sufficient grounds for cancellation of the award and forfeiture of the Earnest Money Deposit. He will also be debarred from participating in bids invited by the Project for one year.

30. Corrupt or Fraudulent Practices

The Employer requires the bidders/Contractors under this contract observe the highest standard of ethics during the procurement and execution of this contract. In pursuance of this policy, the Employer:

- (a) defines, for the purpose of these provisions, the terms set forth below as follows:
- (i) "corrupt practice" means the offering, giving, receiving or soliciting anything of value to influence the action of a public official in the procurement process or in contract execution; and
 - (ii) "fraudulent practice" means a misrepresentation of facts in order to influence a procurement process or the execution of a contract to be detriment of the Employer, and includes collusive practice among Bidders (prior to or after bid submission) designed to establish bid prices at artificial non-competitive levels and to deprive the Employer of the benefits of free and open competition.
- (b) will reject a Bid for award of work if he determines that the Bidder recommended for award has engaged in corrupt or fraudulent practices in competing for the contract in question.
- (c) will declare a Bidder ineligible, either indefinitely or for a stated period of time, to be awarded a contract/contracts if he at any time determines that the Bidder has engaged in corrupt or fraudulent practices in competing for, or in executing, the contract.

31. Integrity Pact

- 31.1 To improve transparency and fairness in the tendering process, SAPDC is implementing Integrity Pact To improve transparency and fairness in the tendering process the Employer is implementing Integrity Pact. Integrity Pact is deemed as part of the contract so that the prospective bidders are bound by its provisions.

The Integrity Pact, signed by all the prospective Bidders and the Employer, shall commit the persons/officials of both the parties, not to exercise any corrupt/fraudulent/collusive/coercive practices in the Tendering process and also during implementation of the Contract. Only those Bidders who have entered into Integrity Pact with the Employer shall be eligible to participate in the bidding process. Bidders signing Integrity Pact shall not approach the Courts while representing the matters to IEMs and he/she will await their decision in the matter.

Entering into Integrity Pact as per Performa (enclosed at Schedule-F) is a basic qualifying requirement. In case of JV, each partner of JV shall sign Integrity Pact with the Employer. In case of sub-contracting, the Principal contractor shall be responsible for adoption of Integrity Pact by the sub-contractor.

To oversee the compliance of obligation under the Integrity Pact, a panel of Independent External Monitor(s) (IEMs) have been appointed by concerned authority. The Contact address of IEMs are as under:

Sl. No.	Name of IEMs	Address of IEMs
1	Sh. S.P. Srivastava, IPS (Retd.)	1/125, Vineet Khand, Gomtinagar, Lucknow, UP-226010 Email: sps_ips@yahoo.com
2	Smt. Archana Pandey Tiwari, IRS (Retd.)	C-32, Nangal Dewat, Vasant Kunj, New Delhi-110070 Email: ampandey2001@yahoo.com

The Integrity Pact duly signed on behalf of SAPDC is enclosed at **Schedule-F** of the Bid Document. The Integrity Pact shall be downloaded, printed and signed by the bidder and the hard copy shall be submitted in Part-I of Bid.

- 31.2 The successful bidder shall submit duly executed Integrity Pact on Plain Paper prior to signing of Contract Agreement. The Integrity Pact duly signed on behalf of the Employer has been enclosed under **Schedule-F** in this document. The Integrity Pact shall be printed & signed by the bidder/supplier and the hard copy shall be submitted in Part-I (Envelope-I).

SECTION-III

**TENDER FORM, FORMS OF DECLARATION AND UNDERTAKING,
QUALIFICATION INFORMATION FORMS AND SCHEDULES**

TENDER FORM

To

**Chief Engineer (P&C),
Satluj Bhawan, Arun Sadan,
SAPDC Office Complex, Tumlingtar.**

1. We have read and examined the following Bidding Documents relating to “Improvement of Katwaldada to Lumbang Road (RD 0.00 to 1.479 km), Makalu RM-05, Num, Distt. Sankhuwasabha, Nepal under Local Benefit Sharing Plan (LBSP) of Arun-3 Hydro Electric Project (900 MW).”

Section-I	Notice Inviting Tender (NIT)
Section-I-A	Detailed Scope of Work and Specifications
Section-II	Instructions To Bidders (ITB)
Section-III	Tender form, forms of Declaration and Undertaking, Qualification Information Forms and Schedules
Section-IV	General Conditions of Contract (GCC)
Section –V	Contract Forms
Section-VI	Special Conditions of Contract (SCC)
Section- VII	Tender Drawings

2. We hereby tender for execution of the work referred to in the documents mentioned in paragraph one above upon the terms and conditions contained or referred to in the aforesaid documents and in accordance in all respects with the specifications, designs, drawings and other details given herein and at the rates contained in Schedule-A and within the period(s) of completion as given in Schedule-B and subject to such terms and conditions as stipulated in the enclosed Bidding Documents.
3. We agree to keep this tender open for acceptance for 180 days after the last date for submission of bid and also agree not to make any modifications in its terms and conditions on our own accord.
4. Earnest Money Deposit of requisite amount as specified in bidding document is hereby enclosed in the form of a Bank Draft/Manager Cheque/FDR(duly pledged in favour of SAPDC)/Bank Guarantee in favor of SJVN Arun-3 Power Development Company Pvt. Ltd. payable at Khandbari acceptable to SJVN Arun-3 Power Development Company Private Limited. We agree that if we fail to keep the validity of tender open, as aforesaid, or make any modification in the terms and conditions of our tender on our own accord and/or fail to commence the execution of the works as provided in the documents referred to in paragraph-1 above, after the acceptance of our tender, we shall become liable for forfeiture of our earnest money, as aforesaid, and the Employer shall without prejudice to any other right or remedy, be at liberty to forfeit the said earnest money absolutely.

Should this tender be accepted, we agree to abide by and fulfil all the terms and conditions and provisions of the above mentioned Bidding Documents.

We certify that the Tender submitted by us is strictly in accordance with the terms, conditions, specifications etc. as contained in your Bidding Documents, referred to in paragraph-1 above, and it does not contain any deviations to the aforesaid documents. It is further certified that information furnished in the Tender submitted by us is correct to the best of our knowledge and belief.

(Signature of person duly authorized to sign the Tender on behalf of the bidder along with Seal of Company)

Name _____

Designation _____

Contact No. /Email ID _____

Witness:

Name _____

Signature _____ Designation _____

Date _____ Name of Company _____

Name & Address _____

_____ Date: _____

Postal Address _____

Telegraphic Address: _____

Telephone No. _____ Telex

No. _____

Fax No. _____ e-mail _____

FORM OF DECLARATION

M/s.....(name of Bidder) having its registered office at(hereinafter referred to as the Bidder) having carefully studied all the Bidding Documents, specifications, drawings, the local and site conditions etc. pertaining to the Work for “Improvement of Katwaldada to Lumbang Road (RD 0.00 to 1.479 km), Makalu RM-05, Num, Distt. Sankhuwasabha, Nepal under Local Benefit Sharing Plan (LBSP) of Arun-3 Hydro Electric Project (900 MW).” and having undertaken to execute the said works,

DO HEREBY DECLARE THAT:

1. The Bidder is familiar with all the requirements of the Contract.
2. The Bidder has not been influenced by any statement or promise of any person of the Employer but only the Contract Documents.
3. The Bidder is financially solvent.
4. The Bidder is experienced and competent to perform the Contract to the satisfaction of Employer.
5. The Bidder is familiar with all general and special laws, acts, ordinances, rules and regulations of the Municipalities, District, State and Central Government of Nepal that may affect the work, its performance or personnel employed therein.
6. The Bidder hereby authorizes the Employer to seek reference from the bankers of Bidder for its financial position.
7. The Bidder undertakes to abide by all labour welfare legislations.
8. The information / statement submitted by the Bidder along with the bid is true and correct in all respects.

Date:

For and on behalf of the bidder

.....

(Signature of authorized representative of the Bidder, along with his name, Seal of Company)

DECLARATION REGARDING FRAUD AND CORRUPTION

1. We undertake that, in competing for the above work contract (and if the award of work is made to us for execution), we shall strictly observe the laws against fraud and corruption in force in Nepal.
2. We declare and covenant that neither we nor any member of the JV are under a declaration on ineligibility for poor performance / failure, issued by the Govt. of India/ Govt. of Nepal, State Govt./Govt. Deptt. / PSU.

Yours faithfully,

Signature

[Name and Title of Signatory]

[Name of Bidder/Firm]

UNDERTAKING REGARDING BLACKLISTING

To: [Name and address of Employer]

Dear Sir,

It is hereby certified that, we{*Insert Name of Contractor/Firm*}
as an individual or as a partner in JV are not blacklisted by Govt. of India/Govt. of Nepal & its
undertaking as on date. The **Bidder/Firm** will immediately inform to Employer (SAPDC) in case of
any change in the situation any time here in after.

We remain,

Yours sincerely,

Authorized Signature [*In full and initials*]: _____

Name and Title of Signatory: _____

Name of Bidder/Firm _____

Address: _____

Seal of the Bidder/Firm_____

Qualification Information Form-A

AVERAGE ANNUAL TURNOVER

Bidder's Name & Address

To:

SAPDC

We declare that the Average Annual Financial Turnover during the last 3 years, ending 15th July 2021 are as under:

S. No.	Period	Turnover
1.	2018-19 (AD) / 2075-76 (BS)	
2.	2019-20 (AD) / 2076-77 (BS)	
3.	2020-21 (AD) / 2077-78 (BS)	
4.	Average Annual Financial Turnover for the last three (03) completed financial years	

Notes:

- i) The Currency Conversion Rate as available on website www.gocurrency.com as on 28 days prior to application submission deadline, shall be considered for converting the figures from foreign currency into Nepali currency. However, in case the conversion rates are not available on said website, the Employer may consider the conversion rates from other website. The decision of Employer in this regard shall be final.*
- ii) In case of Joint Venture, each partner of Joint Venture should meet the Qualification Criteria in proportion to his interest in the Joint Venture.*

Qualification Information Form-B

STATEMENT OF WORKS COMPLETED DURING LAST 7 YEARS BY THE CONTRACTOR

We declare that we ourselves/ as a member of Joint venture / Contractor have executed the following works during last seven (07) years reckoned from last day of the month previous to the one in which bids are invited:

Sl. No.	Name of Work	Value of Work (awarded/executed)	Name of Client/ employer	Date of LOA/ Agreement	Date of Completion

Note: -

- i. Bidders to fill in the details as provided here-in-above and attach additional pages, if necessary.*
- ii. Bidders to enclose necessary certificates in support of above details.*
- iii. Copy of Joint Venture Agreement also to be furnished where the works have been executed in joint venture.*
- iv. In case of Joint Venture, each partner of Joint Venture should meet the Qualification Criteria in proportion to his interest in the Joint Venture.*

SCHEDULE –A (Bill of Quantity)

Name of Work: PCD-212/2022 “Improvement of Katwaldada to Lumbang Road (RD 0.00 to 1.479 km), Makalu RM-05, Num, Distt. Sankhuwasabha, Nepal under Local Benefit Sharing Plan (LBSP) of Arun-3 Hydro Electric Project (900 MW).”

Sr. No.	Description of item	Unit	Qty	Rate (NPR inclusive of all taxes and duties including VAT)		Amount (NPR inclusive of all taxes and duties including VAT)
				In figures	In words	In figures
1.	Road way excavation in all type of soil as per Drawing and technical specification including removal of stumps and other deleterious matter, all lifts and lead as per Drawing and instruction of the Engineer.	Cum	15783.81			
2.	Earthwork in excavation of foundation of structure in ordinary soil, including construction of shoring and bracing and removal of stumps and others deleterious matters and backfilling with approved materials as per drawing and technical specification.	Cum	5332.59			
3.	Providing and laying of hand pack stone soling with 150mm-200mm thick stone & packing with small stone on prepare surface as per Drawing and technical specification.	Cum	327.76			
4.	Providing and placing machine mixed plain/reinforced cement concrete M15 [1:2:4] for foundation and footing etc. including compaction, curing, testing, and lead as per specification and drawing, all complete work.	Cum	147.87			

5.	Providing and placing machine mixed plain/reinforced cement concrete M10 [1:3:6] for foundation and footing etc. including compaction, curing, testing, and lead as per specification and drawing, all complete work.	Cum	13.87			
6.	Providing and laying Random rubble stone masonry work in cement mortar [1 cement: 6 sand] in structure as per drawing and technical specification, all complete work.	Cum	503.25			
7.	Providing and laying Gabion structure for retaining earth with diaphragm including rolling, cutting weaving, placing, laying sides and diaphragms with binding wire and filling boulder all complete as per Drawing and Technical Specification. Mesh wire -10 Swg [0.0615kg/m], selvedge wire [0.1057kg/m], binding wire 12 Swg [0.0409kg/m] Hexagonal mesh type 100mmX120mm. Box 3mX1mX1m. [16sq.m].	Cum	546			
8.	Providing and laying reinforced cement concrete NP3 flush jointed pipe for culverts including fixing with cement mortar 1:2 as per drawing and technical specification 600mm internal dia.	Rmt	22.5			
9.	Providing and laying reinforced cement concrete NP3 flush jointed pipe for culverts including fixing with cement mortar 1:2 as per drawing and technical specification 900mm internal dia.	Rmt	30			

10.	Providing and applying 12.5mm thick plaster in cement mortar 1:4 with cement mortar as per Technical Specification.	Sqm	1192			
11.	Providing and pointing with cement mortar in cement mortar 1:3 on masonry work in structure as per technical specification.	Sqm	310			
Total (NPR) inclusive of all taxes and duties including VAT						
Discount if any in percentage (%)						

Date:

For and on behalf of the bidder

Place:

**Signature of authorized representative of the Bidder,
along with his name, Seal of Company)**

SCHEDULE –B
CONSTRUCTION METHOD AND SCHEDULE

[To be filled in by the Bidder]

Time for Completion allowed for execution of the Works: 6 (six) months to be reckoned from 15th day from the issuance of Letter of Acceptance

Construction Method and Schedule to be submitted by the bidders along with the bid duly supported by construction plant, equipment & machinery and its planning.

The above schedule shall be supplemented from time to time to achieve the required targets and as per directions of Engineer-in-charge.

SCHEDULE –C

CONSTRUCTION PLANT, EQUIPMENT & MACHINERY AND ITS PLANNING SCHEDULE

Deleted

SCHEDULE-D

**LIST OF PLANT, MACHINERY & EQUIPMENT IMMEDIATELY AVAILABLE WITH THE
CONTRACTOR /TO BE LEASED FOR DEPLOYMENT ON THE WORKS**

Deleted

Schedule-E

Proposed Technical Personnel, Qualification and Experience

Deleted

SECTION –IV

**GENERAL CONDITIONS OF
CONTRACT (GCC)**

GENERAL CONDITIONS OF CONTRACT (GCC)

CLAUSE-1: DEFINITIONS:

In the contract, the following expression shall, unless the context otherwise requires, have the meanings thereby respectively assigned to them:

- (i) **Bill of Quantities or Schedule of Quantities & Prices:** means the priced and completed bill of quantities forming part of the Contract.
- (ii) **Contract:** means the document forming the tender, acceptance thereof and the formal agreement executed between the SJVN Arun-3 Power Development Company Private Limited and the Contractor, together with documents referred to therein.
- (iii) **Contract Price:** means the amount arrived at by multiplying the quantities shown in the Bill of Quantities by the respective item rates as allowed and included in the Letter of Acceptance.
- (iv) **Contractor:** means the successful Bidder who is awarded contract to perform the work covered under these Bidding Documents and shall be deemed to include the Contractor's successors, executors, representatives or assigns.
- (v) **Corporation or Employer:** means the SJVN Arun-3 Power Development Company Private Limited having its office at Tumlingtar, Distt, Sankhuwasabha, Nepal and includes therein legal representatives, successors and assigns.
- (vi) **Construction Drawing:** means such drawings approved in writing by the Engineer-in-Charge/ Employer and issued for actual construction of the Works from time to time by the Engineer-in-Charge.
- (vii) **Contractor's Equipment:** means all appliances and things of whatsoever nature (other than Temporary Works) required for the execution and completion of the Works and the remedying of any defects therein, but does not include Plant, materials or other things intended to form or forming part of the Permanent Works.
- (viii) **Cost:** The word "cost" shall be deemed to include overhead costs whether on or off the site.
- (ix) **Day:** means a calendar day beginning and ending at midnight.
- (x) **Drawing:** means and shall include Tender drawing and Construction drawing.
- (xi) **Engineer-in-Charge/Engineer:** means the Engineering Officer nominated by the Employer or its duly authorized representative to direct, supervise and be in charge of the works for the purpose of this contract.
- (xii) **Letter of Award or Acceptance:** means a letter from the Employer/Engineer-in-Charge conveying the acceptance of the tender/offer subject to such reservations as may have been stated therein.
- (xiii) **Permanent works:** means the permanent works to be executed (including Plant) in accordance with the Contract.
- (xiv) **Plant:** means machinery, apparatus and like intended to form or forming part of Works.
- (xv) **Site:** means the land and/or other places, on or through which the works are to be executed including any other lands or places which may be allotted for the purpose of the contract
- (xvi) **Specifications:** means the Technical specification of the Works included in the Contract and any modification thereof or addition thereto made under Clause 18 or submitted by the Contractor and approved by the Engineer.
- (xvii) **Sub-Contractor:** means any person named in the Contract as a Sub-Contractor for a part of the Works or any person to whom a part of the Works has been subcontracted with the consent of the Employer and the legal successors in title to such person, but not any assignee of any such person.

- (xviii) **Time for Completion:** means the time for completing the execution of and passing the Tests on Completion of the Works or any Section or part thereof as stated in the Contract (or as extended under Clause 39) calculated from the Commencement Date.
- (xix) **Temporary works:** means all temporary works of every kind (other than Contractor's Equipment) required in or about the execution and completion of the Works and the remedying of any defects therein.
- (xx) **Tender Drawings:** means the drawings referred to in the Specifications and/or appended with the Bidding Documents.
- (xxi) **Urgent Works:** means any urgent measure, which in the opinion of the Engineer-in-Charge, becomes necessary at the time of execution and/or during the progress of work to obviate any risk of accident or failure or to obviate any risk of damage to the structure, or required to accelerate the progress of work or which become necessary for security or for any other reason the Engineer-in-Charge may deem expedient.
- (xxii) **Week:** means seven consecutive calendar days.
- (xxiii) **Work or Works:** means Permanent Works and/or Temporary Works to be executed in accordance with the Contract.

CLAUSE 2: INTERPRETATION

- 2.1 Words importing the singular only shall also include the plural; he includes she and vice versa unless this is repugnant to the context. Unless specifically defined, words shall have normal meaning under the language of Contract.
- 2.2 Heading and marginal notes in these General Conditions shall not be deemed to form part thereof or be taken into consideration in the interpretation or construction thereof of the Contract.
- 2.3 Any error in description, quantity or price in Bill of Quantities or any omission there from shall not vitiate the Contract or release the Contractor from execution of the whole or any part of the Works comprised therein according to drawings and Specifications or from any of his obligations under the Contract.
- 2.4 Detailed drawings shall be followed in preference to small scale drawings (sketch drawings) and figured dimensions in preference to scaled dimensions. In the case of discrepancy between the Letter of acceptance issued by Employer, Special Conditions of Contract, Technical Specifications, General Conditions of Contract, the Tender Drawings and/or Bill of Quantities and other documents of Contract the following order of precedence shall prevail:
 - a) Agreement
 - b) Letter of Acceptance;
 - c) Special Conditions of Contract;
 - d) General Conditions of Contract ;
 - e) Detailed Scope of Work and Technical Specifications;
 - f) Priced Bill of Quantities;
 - g) Contractor's Bid other than BOQ;
 - h) Tender drawings;
 - i) Instructions to Bidders; and
 - j) Any other document forming part of the Contract.

CLAUSE 3: SECURITY DEPOSIT

- 3.1 The Security Deposit shall comprise the following:
 - (i) Performance Security Deposit to be furnished by the Contractor within 30 days of issue of Letter of Acceptance.
 - (ii) Retention Money to be recovered from Interim bills of the Contractor.

- 3.2 The Contractor shall within 30 (Thirty) days from the date of issue of Letter of Acceptance, furnish a **Performance Security Deposit of 5% (five percent)** of the Contract Price for due performance of contract, in the form of a demand draft /Manager's Cheque/ FDR / Banker Cheque/Bank Guarantee issued by a Class A bank situated in Nepal acceptable to SJVN Arun-3 Power Development Company Private Limited. The performance security deposit furnished in the form of bank guarantee shall be valid till 45 days beyond Defect Liability Period.
- 3.3 **Retention money shall be deducted by the Engineer-in-Charge from the interim bills of the Contractor @ 5% (five percent)** of the total value of each bill of the work done (including those of price variation) towards security deposit.
- 3.4 If the Contractor expressly requests in writing, he will be permitted to convert the amount of Retention Money deducted from his interim bills into Bank Guarantee to be submitted in the prescribed form, when cumulative retention money reaches more than 50% of the maximum limit i.e. 50% of 5% of Contract Price, subject to minimum amount of **NPR 1.6 Crore** or more in each event, if applicable. The Contractor shall ensure and demonstrate that all such amounts shall be used strictly for completion of same work.
- 3.5 All compensation or other sums of money payable by the Contractor to the Employer under the terms of this Contract or any other contract or on any other account whatsoever may be deducted from Security Deposit. Also in the event of the Contractor's Security Deposit being reduced by reasons of such deductions, as aforesaid, the Contractor shall, within 14 days of receipt of notice of demand from the Engineer-in-Charge, make good the deficit in Security Deposit.
- 3.6 Should there arise any occasion under the Contract due to which the periods of validities of Bank Guarantees as may have been furnished by the Contractor from time to time, are required to be extended/renewed, the Contractor shall get the validity periods of such guarantees extended/renewed, and furnish these to the Engineer-in- Charge one month before the expiry date of the aforesaid Guarantees originally furnished failing which the existing Bank Guarantees shall be invoked by the Engineer-in-charge. Also in case of any deficit in securities on any account as might occur or is noticed, the Contractor shall forthwith recoup/replace the same with acceptable Security Deposit.

CLAUSE 4: REFUND OF SECURITY DEPOSIT

- 4.1 The Performance Security Deposit less any amount due shall, on demand, **be returned to the Contractor on or before 14th day after issuance of Defects Liability Certificate** (referred in Clause 43 and 57 hereof). The retention money shall be returned after issuance of completion certificate by the EIC. No interest on the amount of Security Deposit shall be paid to the Contractor at the time of release of Security Deposit as stated above.

CLAUSE 5: SUFFICIENCY OF TENDER

- 5.1 The Contractor shall be deemed to have satisfied himself as to the correctness and sufficiency of the Tender and of the rates and prices stated in the Bill of Quantities, all of which shall, except insofar as it is otherwise provided in the Contract, cover all his obligations under the Contract and all matters and things necessary for the proper execution and completion of the Works and the remedying of any defects therein.

CLAUSE 6: CONTRACT DOCUMENTS

- 6.1 The Contract shall be signed in two originals, one for each party to the Contract. The language of the contract shall be English.
- 6.2 One copy of Contract shall be kept by the Contractor on the Site in good order and the same shall at all reasonable time be available for inspection and use by the Engineer-in-Charge, his representatives or by other Inspecting Officers.
- 6.3 None of these Documents shall be used by the Contractor for any purpose other than that of this contract.

CLAUSE 7: LIFE-SAVING APPLIANCES AND FIRST-AID EQUIPMENT

- 7.1 The Contractor shall provide and maintain upon the works sufficient, proper and efficient life-saving appliances and first-aid equipment in accordance with the requirement of International Labour Organization (ILO) Convention No.62. The appliances and equipment shall be available for use at all time.

CLAUSE 8: DUTIES AND POWERS OF ENGINEER-IN-CHARGE'S REPRESENTATIVE

- 8.1 The duties of the representative of the Engineer-in-Charge are to watch and supervise the works and to test and examine any materials to be used or workmanship employed in connection with the works.
- 8.2 The Engineer-in-Charge may, from time to time in writing, delegate to his representative any of the powers and authorities, vested in the Engineer-in-Charge and shall furnish to the Contractor a copy of all such written delegation of powers and authorities. Any written instruction or written approval given by the representative of the Engineer-in-Charge to the Contractor within the terms of such delegation shall bind the Contractor and the Employer as though it has been given by the Engineer-in-Charge.
- 8.3 Failure of the representative of the Engineer-in-Charge to disapprove any work or materials shall be without prejudice to the power of the Engineer-in-Charge thereafter to disapprove such work or materials and to order the pulling down, removal or breaking up thereof. The Contractor shall, at his own expense, again carry out such works as directed by the Engineer-in-Charge.
- 8.4 If the Contractor is dissatisfied with any decision of the representative of the Engineer-in-Charge, he will be entitled to refer the matter to the Engineer-in-Charge who shall thereupon confirm, reverse or vary such decision and the decision of the Engineer-in-Charge in this regard shall be final and binding on the Contractor.

CLAUSE 9: ASSIGNMENT AND SUBLETTING

- 9.1 The Contractor shall not sub-let, transfer or assign the whole or any part of the work under the Contract. Provided that the Engineer-in-Charge may, at his discretion, approve and authorize the Contractor to sub-let any part of the Work, which, in his opinion, is not substantial, after the Contractor submits to him in writing the details of the part of the work(s) or trade proposed to be sublet, the name of the sub-Contractor thereof together with his past experience in the said work/trade and the form of the proposed sub-contract. Nevertheless any such approval or authorization by the Engineer-in-Charge shall not relieve

the Contractor from his any or all liabilities, obligations, duties and responsibilities under the Contract. The Contractor shall also be fully responsible to the Employer for all the acts and omissions of the sub-Contractor, his employees and agents or persons directly employed by the Contractor. However, the employment of piece-rate workers and purchase of material shall not be construed as sub-letting. Request for sub- contracting shall contain.

- (a) Contractor's certification regarding the financial soundness of the proposed Sub - Contractor for the work;
- (b) its scope and estimated value in relation to the Contract Price;
- (c) experience of the Sub-Contractor, in the related areas of work;
- (d) the manpower, equipment, material and other resources available with the Sub- Contractor for the work;
- (e) domicile of the Sub-Contractor and particulars of its other existing operations or contracts if any, in India.

CLAUSE 10: FACILITIES TO OTHER CONTRACTORS

10.1 The Contractor shall, in accordance with the requirements of the work as decided by the Engineer-in-Charge, afford all reasonable facilities to other Contractors engaged contemporaneously on separate contracts and for departmental labour and labour of any other properly authorized authority or statutory body which may be employed at the site for execution of any work not included in the Contract or of any contract which the Employer may enter into in connection with or ancillary to the works. In all matters of conflict of interest, the Engineer-in-Charge shall direct what compromise should be made and his decision shall be final and binding on the parties.

10.2 If, however, pursuant to Sub-Clause 10.1 the Contractor shall, on the written request of the Engineer-in-Charge:

- (a) make available to any such other Contractor, or to the Employer or any such authority, any roads or ways the maintenance of which is the responsibility of the Contractor ,
- (b) permit the use, by any such, of Temporary facilities or Contractor's Equipment on the Site, or
- (c) provide any other service of whatsoever nature for any such, the Engineer-in-Charge shall determine the payment admissible to the Contractor at the cost of other Contractors or Employer as the case may be.

CLAUSE 11: CHANGES IN CONSTITUTION

11.1 Where the Contractor is a partnership firm, prior approval in writing of the Engineer-in-Charge shall be obtained before any change is made in the constitution of the firm. Where the Contractor is an individual, such approval, as aforesaid, shall likewise be obtained before the Contractor enters into any partnership firm which would have the right to carry out the work undertaken by the Contractor. If prior approval as aforesaid is not obtained, the Contract shall be deemed to have been assigned in contravention of Clause 38 hereof and the same action will be taken and the same consequences shall ensure as provided for in the said Clause 38.

CLAUSE 12: POSSESSION AND USE OF SITE

12.1 Save in so far as the Contract may prescribe:

- (a) the extent of portions of the Site of which the Contractor is to be given possession from time to time,
- (b) the order in which such portions shall be made available to the Contractor, and, subject to any requirement in the Contract as to the order in which the Works shall be executed, the Employer will give to the Contractor possession of
- (c) so much of the Site, and
- (d) such access as, in accordance with the Contract, is to be provided by the Employer as may be required to enable the Contractor to commence and proceed with the execution of the Works in accordance with the program referred to in Clause 14, if any, and otherwise in accordance with such reasonable proposals as the Contractor shall, by notice to the Engineer. The Employer will, from time to time as the Works proceed, give to the Contractor possession of such further portions of the Site as may be required to enable the Contractor to proceed with the execution of the Works in accordance with such program or proposals, as the case may be.

12.2 If the Contractor suffers delay from failure on the part of the Employer to give possession in accordance with the terms of Sub-Clause 12.1, the Engineer-in-Charge shall, determine any extension of time to which the Contractor is entitled under Clause 39.

12.3 The Contractor shall be responsible to arrange the land for Contractor's infrastructure works namely field office(s), colony, workshop(s), stores, magazines for explosives in isolated locations, assembly-yard, and access thereto over routes as may be required for execution of the Works at his own cost and Employer shall not be responsible for making available the same.

12.4 The Contractor shall provide at his own cost all temporary pathways/roads required at site or to quarries or borrow areas and shall alter, adopt and maintain the same as required from time to time and shall bear all expenses and charges for special or temporary way leaves required by him in connection with access to the site and shall take up and clear them away and make good all damages done to the site as and when no longer required and as and when ordered by the Engineer-in-Charge.

12.5 **Within 30 days from the issuance of Letter of Acceptance, the Contractor shall establish its office at site. An amount of NPR 1,00,000/- per month shall be deducted from the bills due to the Contractor in case of non-establishment of site office.**

CLAUSE 13: ADVANCES AND RECOVERY THEREOF: Not applicable (Clause Deleted from Sr. No. 13.1 to 13.6)

CLAUSE 14: COMMENCEMENT OF WORK

14.1 The Contractor shall commence the Work(s) within 15 days after issuance of Letter of Acceptance and shall proceed with the same without delay as may be expressly sanctioned or ordered by the Engineer-in-Charge. If the Contractor commits default in the commencement of work within 30 days of issue of Letter of Acceptance, the Engineer-in-Charge shall without prejudice to any other right or remedy be at liberty to cancel the Contract and earnest money shall be forfeited.

- 14.2 The Contractor shall submit along with his tender, the construction planning, phasing & sequence of construction, time & progress chart within the framework of construction schedule for achieving the completion targets of Work(s) as a whole showing the order or procedure and a statement showing the method and techniques of construction by which the Contractor proposes to carryout the Works. It shall indicate the commencement and completion of various trades or sections of the Works, distribution and balancing of work-load pertaining to construction activities in various structures/component parts of Works into working seasons duly taking into account working months available in each working season and number of working days available in the working months, to arrive at seasonal monthly average and seasonal monthly peak progress with corresponding time periods. Such construction planning will be discussed and finally agreed with successful Bidder before award of work and the same shall form an integral part of the agreement. Contractor shall follow such an agreed planning & scheduling. However, it shall not relieve the Contractor of any of his duties, obligations or responsibilities under the Contract.
- 14.3 Within 15 days of issue of Letter of Acceptance, the Contractor shall submit, to Engineer for his consent Master Control Network including but not limited to comprehensive bar chart stipulating quantities of work to be executed supported by machinery deployment schedule for the execution of Works within the overall time frame included in the schedule incorporated in the Contract. The Contractor shall provide, in writing, general description of arrangements and methods proposed to be adopted for execution of Works within Time for Completion duly taking into account the milestones for the purpose of levying liquidated damages.
- 14.4 During the execution of Works, if it appears to the Engineer in-charge, that actual progress of works does not conform to the program consented by him, the Contractor shall produce a revised program dealing modifications to such program necessary for ensuring completion of works within Time for Completion. **However, in case if the Engineer-in-charge observes that the progress of works is grossly not commensurate with the agreed schedule, SAPDC reserves its right to terminate the contract and get the work executed at the risk and cost of the Contractor.**
- 14.5 The Contractor shall provide a detailed month-wise cash flow estimate at the beginning of each financial year duly revised at quarterly intervals if required so by the Engineer-in-Charge.
- 14.6 The submission to and consent by the Engineer-in-Charge of such programs or the provision of such general descriptions or cash flow estimates shall not relieve the Contractor of any of his duties or responsibilities under the Contract.

CLAUSE 15: WORKS TO BE CARRIED OUT IN ACCORDANCE WITH SPECIFICATIONS, DRAWINGS AND ORDERS ETC.

- 15.1 The Contractor shall execute the Works in the most substantial and workmanlike manner and both as regards material and otherwise in every respect in strict conformity with the Specifications. The Contractor shall also conform exactly, fully and faithfully to the designs, drawings, Specifications and instructions in writing in respect of the work, duly issued by the Engineer-in-Charge from time to time. The Contractor shall take full responsibility for the adequacy of all the site operations and methods of construction.

The Contractor shall give prompt notice to the Engineer-in-Charge, with a copy to the Employer, of any error, omission, fault or other defect in the design of or Specifications for the Works which he discovers when reviewing the Contract or executing the Works.

15.2 The Contractor shall be entitled to receive, if any the documents set forth herein during the performance of the Contract:

- | | |
|------------------------------------------------------------------------------------|--------|
| a. Construction drawings and revisions thereto | 3 sets |
| b. Specifications or revisions thereof other than standard printed Specifications. | 2 sets |
| c. Explanations, instructions etc. | 1 copy |

Such further drawings, explanations, modifications and instructions, as the Engineer-in-Charge may issue to the Contractor from time to time in respect of the Work, shall be deemed to form integral part of the Contract and the Contractor shall to carry out the Work accordingly.

15.3 The Contractor shall give notice to the Engineer-in-Charge, whenever planning or execution of the Works is likely to be delayed or disrupted unless any further drawing or instruction is issued by the Engineer-in-Charge within a reasonable time. The notice shall include details of the drawing or instruction required and of why and by when it is required and of any delay or disruption likely to be suffered if it is late.

15.4 If, by reason of any failure or inability of the Engineer-in-Charge to issue, within a time reasonable in all the circumstances, any drawing or instruction for which notice has been given by the Contractor in accordance with Sub-Clause 15.3, the Contractor suffers delay then the Engineer-in-Charge shall, after approval of the Employer determine any extension of time to which the Contractor is entitled under Clause 39.

CLAUSE 16: SETTING OUT THE WORKS

16.1 The Engineer-in-Charge shall establish/indicate the Bench Marks and convey the same in writing to Contractor immediately after Letter of Acceptance. Engineer-in-Charge shall be responsible for correctness of such data / bench marks conveyed to the Contractor.

16.2 The Contractor shall be responsible for the true and proper setting out of all the work (in relation to the afore-mentioned Bench Marks) for the correctness of the location, grades, dimensions and alignment of all components of the work; and for the provisions of all instruments, appliances, materials and labour required in connection therewith. If at any time during the progress of work, any error shall appear or arise in the location, grades, dimensions, or alignment of any part of the Work, the Contractor on being required to do so by the Engineer-in-Charge shall, subject to Clause 16.1 hereof, at his own expense, rectify such error to the satisfaction of the Engineer-in-Charge.

16.3 The Contractor shall afford all reasonable facilities and assistance to the Engineer-in-Charge for checking the setting out and lines and grades established by the Contractor. The checking of any setting out or of any line and grade by the Engineer-in-Charge shall not in any way relieve the Contractor of his responsibility for the correctness thereof.

CLAUSE 17: URGENT WORKS

If any urgent work (in respect whereof the decision of the Engineer-in-Charge shall be final and binding) becomes necessary, the Contractor shall execute the same as may be directed.

CLAUSE 18: DEVIATIONS

18.1 The Engineer-in-Charge shall have powers to make any deviations in the original specifications or drawings or designs of the works or any part thereof that are, in his opinion, necessary at the time of or during the course of execution of the Works. For the aforesaid purpose or for any other reason, if it shall, in the opinion of the Engineer-in-Charge, be desirable, he shall also have the powers to make Deviations, such as (i) Variations (ii) Extra Items (iii) Additions/Omissions and (iv) Alterations or Substitutions of any kind. No such Deviations in the specifications or drawings or designs or Bill of Quantities, as aforesaid, shall in any way vitiate or invalidate the Contract and any such Deviations which the Contractor may be directed to do shall form integral part of the Contract as if originally provided therein and the Contractor shall carry out the same on the same terms & conditions in all respects on which he agreed to do the works under the contract subject to clause 18.2 hereof.

18.2 The rates for such items of work as are required to be executed due to Deviations, as stated in sub-clause 18.1 above shall be payable in the manner as stated hereunder :

- i) The rates already provided in the Bill of Quantities, shall apply in respect of the same item(s) of work to be executed due to Variation, subject to the condition that change in quantity multiplied by BOQ rate do not exceed 0.25 % of the Contract Price. **However, the quoted rates shall hold good for all minus Variations.**
- ii) In case of items for which rates are not available in the Bill of Quantities, the rates of such items as far as practicable **shall be derived from the quoted rates of analogous item(s)** in the Bill of Quantities.
- iii) In the cases, where analogous items are not available in the Bill of Quantities, such items shall be termed as **extra items** and the rates for such items and also for items exceeding the prescribed limit as mentioned in clause 18.2 (i) above, the Contractor, within 15 days (or as agreed by the Engineer) of receipt of order to execute such items shall submit rate analysis to the Engineer-in-Charge supported by documentary evidence of basic rates adopted therein, notwithstanding the fact that the rates for such items exist in the Contract, having regard to the cost of materials (including transportation and taxes, levies if paid), actual wages for labour and ownership & operational cost of construction equipment as per standard norms or if standard norms are not specified/available then on the basis of labour/materials/equipment actually engaged for the particular work. The standard norms for materials and labour specified herein shall mean those specified in *“DOR analysis of rates and the basic rates of Sankhuwasabha and Morang Distt. and if not available therein the same may be derived/taken as specified in Guidelines for preparation of Project Estimates for River Valley Projects (Latest Version) of Central Water Commission, Govt. of India. Standard norms for machinery use shall mean those specified in “Guidelines for preparation of Project Estimates in Nepal”.*

Over and above the cost of labour, material arranged by the Contractor and ownership & operational cost of plant and machinery, an element of such percentage as 15 % shall be allowed to cover the Contractor's overheads, profits, and supervision charges.

The Engineer-in-Charge shall examine the rate analysis submitted by the Contractor and fix the rates accordingly whose decision shall be conclusive, final and binding on the Contractor.

18.3 If requested by the Contractor, the Time for Completion of the Works shall, in the event of

any deviation resulting in additional cost over the Contract Price, be extended in the proportion which the altered, additional or substituted work bears to the original Contract Price plus such further additional time as may be considered reasonable by the Engineer-in-Charge.

- 18.4 Under no circumstances, the Contractor shall suspend the work on account of non-settlement of rates of such Deviated items.
- 18.5 Provided that no deviations instructed to be done by the Engineer-in-charge pursuant to Clause 18.1 shall be valid under Clause 18.2 unless within 15 days of the date of such instruction before the commencement of execution of deviated items, notice shall have been given either;
- a) by the Contractor to the Engineer-in-Charge of an intention to Claim extra payment or varied rate or price or
 - b) by Engineer-in-Charge to the Contractor of his intention to vary a rate or price for the deviated items.

CLAUSE 19: CONTRACTOR'S SUPERVISION

- 19.1 The Contractor shall appoint at his own expense adequate number of engineers with sufficient experience to supervise the Works.

The Contractor or his authorized representatives present at the site(s) shall superintend the execution of the works with such additional assistance in each trade, as the work involved shall require and considered reasonable by the Engineer-in-Charge. Directions/instructions given by the Engineer-in-Charge to the Contractor's authorized representatives shall be considered to have the same force as if these had been given to the Contractor himself.

CLAUSE 20: INSTRUCTIONS AND NOTICES

- 20.1 Except as otherwise provided in this Contract, all notices to be given on behalf of the Employer and all other actions to be taken on its behalf may be given or taken by the Engineer-in-Charge or any officer for the time being entrusted with the functions, duties and powers of the Engineer-in-Charge.
- 20.2 **All written instructions, notices and communications** etc. under the contract shall be given in writing and any such oral orders/instructions given shall be confirmed in writing and no such communication which is not given or confirmed in writing shall be valid. **Correspondences made through mail pursuant to issuance of Letter of Acceptance (LOA) shall not be entertained.**
- 20.3 Either party may change a nominated address to another address by prior notice to the other party.
- 20.4 The Engineer-in-Charge shall communicate or confirm the instructions to the Contractor in respect of the execution of work in a 'Work Site Order Book' maintained in the office of the Engineer-in-Charge or his representative and the Contractor or his authorized representative shall confirm receipt of such instructions by signing the relevant entries in this book. If required by the Contractor, he shall be furnished a certified true copy of such instruction(s).

CLAUSE 21: CONSTRUCTION EQUIPMENT

- 21.1 The Contractor shall provide and install all necessary construction equipment and machinery required for the execution of the Works under the Contract, at his cost and shall use such methods and appliances for the purpose of all the operations connected with the Work covered by the Contract which shall ensure the completion of Work(s) within the specified Time for completion.
- 21.2 The Bidder shall submit full details of construction equipment and machinery proposed to be deployed for the work(s) along with its planning schedule showing month wise phasing in accordance with the construction schedule. The Construction, equipment & machinery schedule as submitted shall be mutually discussed and finalised with the successful Bidder and approved before award of work and these shall form integral part of Contract. The Contractor shall deploy construction equipment and machinery as per agreed schedule. Provided further that in case of slow rate of Progress of Works, the Contractor should supplement the agreed schedule of equipment with additional equipment so as to ensure completion of Works within Time for Completion at no extra cost to Employer.
- 21.3 The Contractor shall not remove construction equipment, except for purpose of removing it from one part of the site to another, without written consent of the Engineer.

Provided always that any such approval of Construction equipment schedule in 21.2 shall not absolve the Contractor of his obligations for due execution of the Works within the Time for Completion as per the Contract. Subject to the availability of any of Employer's equipment and at the written request of the Contractor, such equipment and machinery may be issued to the Contractor on hire for being deployed on the Work contracted for, at pre-determined rates, terms and conditions at the sole discretion of the Engineer-in-Charge.

CLAUSE 22: PATENT RIGHTS

The Contractor shall indemnify the Employer, its representatives or its employees against any action, claim or proceedings relating to infringement or use of any patent or design or any alleged patent or design rights and shall pay any royalties or other charges which may be payable in respect of any article or material or part thereof included in the Contract. In the event of any claim being made or action being brought against the Employer or any agent, servant or employee of the Employer in respect of any such matters as aforesaid, the Contractor shall immediately be notified thereof. Provided that such indemnity shall not apply when such infringement has taken place in complying with the specific directions issued by the Employer, but the Contractor shall pay any royalties or other charges payable in respect of any such use, the amount so paid being reimbursed to the Contractor only if the use was the result of any drawings and/or specifications issued after submission of the tender.

CLAUSE 23: MATERIALS

- 23.1 Subject to clause 31.2, the Contractor shall at his own expense provide/arrange all materials required for the bonafide use on work under the Contract.
- 23.2 All materials to be provided by the Contractor shall be in conformity with the Specifications laid down in the Contract and the Contractor shall furnish from time to time proof and samples, at his cost, of the materials as may be specified by the Engineer-in-Charge for his

approval before use in the Works. The Engineer-in-Charge shall also have powers to have such tests, in addition to those specified in the Contract, as may be required and the Contractor shall carry out the same. The cost of materials consumed in such tests and also expenses incurred thereon shall be borne by the Contractor in all cases except when the materials are agreed to be issued by the Employer under the contract and also where such tests which are in addition to those provided in the Contract.

- 23.3 The Engineer-in-Charge or his representative shall be entitled at any time to inspect and examine any materials intended to be used in or on the works, either on the site or at factory or workshop or other place(s) where such materials are assembled, fabricated, manufactured, or at any place where these are lying or from where these are being obtained. For this purpose, the Contractor shall afford such facilities as may be required for such inspection and examination.
- 23.4 The Engineer-in-Charge shall have full powers for removal of any or all materials brought to site by the Contractor, which are not in accordance with the Contract Specifications or samples, approved by him. Should the Contractor fail to remove the rejected materials, the Engineer-in-Charge shall be at liberty to have them removed by other means at the Contractor's cost. The Engineer-in-Charge shall have full power to procure other proper materials to be substituted at Contractor's costs.

CLAUSE 24: POWER SUPPLY

- 24.1 The Contractor shall make arrangements for the full anticipated requirement of construction power at his own risk and cost.
- The Employer, if requested by the Contractor will provide assistance to the Contractor to obtain construction power from grid to meet part requirement as standby arrangement. Contractor will not have any claim, if construction power is not available from the grid or the quality or availability of Grid Power is not up to the mark. The Contractor will also be responsible for making all payments to the concerned authorities and will make no claims if the power is not available due to grid failure or otherwise.
- 24.2 The Contractor at his own cost shall provide and install all necessary electrical installations and other temporary equipments for further distribution and utilization of energy for power and lighting and shall remove the same on completion of the Works. All jobs shall be suitably lighted by the Contractor at his own expenses for their proper execution and inspection in accordance with the provisions of laws in force.
- 24.3 No payment shall be made by the Employer for generation, distribution and consumption of electricity in execution of Works by the Contractor.

CLAUSE-25: SUPPLY OF WATER

- 25.1 The Contractor shall make his own arrangements for water required for and in connection with the work at his own cost. It shall be the responsibility of the Contractor to satisfy himself that the water arranged by him is fit for construction & consumption & he shall adequately treat such water whenever it is not found fit for the said purposes.

CLAUSE-26: WATCHING AND LIGHTING

- 26.1 The Contractor shall provide and maintain at his expense all lights, guards, fencing and watching when and where necessary or as required by the Engineer-in-Charge for the protection of the works or for the safety and convenience of those employed on the works or the public.

CLAUSE 27: WORK DURING NIGHT OR ON SATURDAYS AND HOLIDAYS

27.1 Subject to any provisions to the contrary contained in the Contract, the Contractor shall have the options to carry out the works continuously during day and night, Saturday or holidays, without any additional cost to Employer.

CLAUSE 28: SITE DRAINAGE, PROTECTION OF TREES AND PREVENTION OF NUISANCE

28.1 The Contractor shall, throughout the execution and completion of the Works and remedying of any defects therein have full regard for the safety of all persons entitled to be upon the Site and keep the Site (so far as the same is under his control) and the Works (so far as the same are not completed or occupied by the Employer) in an orderly state appropriate to the avoidance of danger to such persons.

28.2 The Contractor shall endeavor to protect from damage, the trees marked by the Engineer-in-Charge at the site of work or in the lands licensed to him for use under the contract. Where necessary, the Contractor shall provide at his expense temporary fencing to protect such trees. No tree shall be cut unless authorized by Engineer-in-Charge in writing to do so.

28.3 The Contractor shall at no time, cause or permit any nuisance on the site or cause anything which shall cause unnecessary disturbance or inconvenience to the public in general and owners/tenants/occupants of adjacent properties.

CLAUSE 29: LABOUR

29.1 The Contractor shall:

- i) employ labour in sufficient numbers to maintain the required rate of progress and quality to ensure workmanship of the degree specified in the Contract. The Contractor shall not employ in connection with the works any person who has not completed fourteen years of age or as applicable in Nepal.
- ii) maximize use of Nepali resources and give first consideration and full and fair opportunity to technically and commercially qualified Nepalese citizens, materials and firms provided that in each case, the use of such Nepali resources meet the quality, quantity and availability requirements of the Company and provided further that use of such resources does not have a material and adverse impact on the costs and the timelines for the Project
- iii) comply with the Laws of Nepal including the Labour Act, 2048 and Labour Regulation, 2050

29.2 The Contractor shall furnish and deliver fortnightly to the Engineer-in-Charge, a distribution return of the number and description by trades of the works of people employed on the works. The Contractor shall also submit on the 4th and 19th day of every month to the Engineer-in-Charge a true statement showing in respect of the second half of the preceding month and the first half of the current month.

- (i) The accidents that occurred during the said fortnight showing the circumstances under which they happened and the extent of damage and injury caused by them, and
- (ii) The number of female workers who have been allowed maternity benefit as provided in

the **Labour Act, 1991(2048)** applicable in Nepal.

29.3 During continuance of the Contract, the Contractor and his sub-Contractors shall abide at all times by all existing labour enactments and rules made thereunder, regulations, notifications and bye laws of State or Central Government or local authority and any other labour law (including rules), regulations, bye laws that may be passed or notification that may be issued under any labour law in future either by the State or the Central Government or the local authority. The Contractor shall keep the Employer indemnified in case any action is taken against the Employer by the competent authority on account of contravention by the Contractor of any of the provisions of any Act or rules made thereunder, regulations or notifications including amendments. If the Employer is caused to pay or reimburse, such amounts as may be necessary to cause or observe, or for non-observance of the provisions stipulated in the notifications/bye laws/acts/rules/regulations including amendments, if any, on the part of the Contractor, the Engineer/Employer shall also have right to recover from the Contractor any sum required or estimated to be required for making good the loss or damage suffered by the Employer.

The employees of the Contractor and his sub-Contractor in no case shall be treated as the employees of the Employer at any point of time.

The contractor shall comply with all the prevailing laws and acts (as mentioned under) of Nepal, amended from time to time.

- a. Labour Act, 1991 (2048)
- b. Foreign Investment and Technology Transfer Act, 1992 (2049)
- c. Environment Protection Act, 1997
- d. Human Right Commission Act, 1997 (2053)
- e. Company Act, 1997 (2053)
- f. Contract Act, 2000 (2056)
- g. Trade Union Act (2049)
- h. Labour and employment policy (2062)

The above Labour laws/Acts applicable in Nepal are indicative and contractor shall follow all the concerned laws/Acts applicable in Nepal for this work.

29.4 The Engineer-in-Charge shall on a report having been made by an authorized Inspecting Officer as defined in the Contract Labour (Regulation and Abolition) Act and Rules or on his own in his capacity as Principal Employer, have the power to deduct from the amount due to the Contractor any sum required or estimated to be required for making good the loss suffered by worker(s) by reasons of non-fulfillment of the conditions of the Contract for the benefit of workers, non-payment of wages or of deductions made by him from wages which are not justified by the terms of the contract or non-observance of the relevant Acts and Rules with amendments made from time to time. If the Employer makes payment to Contractor's labour due to non-payment of wages to labour by the Contractor, the Employer shall recover the amount thus paid from the next Interim Bill of the Contractor or any other dues of the Contractor along with 15% interest per annum and administration charges for the number of days the said amount remains outstanding.

29.5 The Contractor shall indemnify the Employer against any payments to be made under and for observance of the Regulations, Laws, Rules as stipulated in clause 29.4 above without prejudice to his right to claim indemnity from his sub-Contractors. In the event of the Contractor's failure to comply with the provisions of sub-clause 29.4 or in the event of decree

or award or order against the Contractor having been received from the competent authority on account of any default or breach or in connection with any of the provisions of sub-clause 29.4 above, the Engineer-in-Charge, without prejudice to any other right or remedy under the Contract, shall be empowered to deduct such sum or sums from the bills of the Contractor or from his Security Deposit or from other payments due under this contract or any other Contract to satisfy within a reasonable time the provisions of the various Acts/Laws/Rules/Codes as mentioned under sub-clause 29.4 above, on the part of the Contractor under the Contract on behalf of and at the expenses of the Contractor and make payment and/or provide amenities/facilities/services accordingly. In this regard, the decision of the Engineer-in-Charge shall be conclusive and binding on the Contractor.

- 29.6 The Contractor shall at his own expense comply with or cause to be complied with the Provisions/Rules provided for welfare and health of Contract Labour in the Contract Labour (Regulation & Abolition) Act or as applicable in Nepal and other relevant Acts and Rules framed thereunder or any other instructions issued by the Employer in this regard for the protection of health and for making sanitary arrangements for workers employed directly or indirectly on the works. In case, the Contractor fails to make arrangements as aforesaid, the Engineer-in-Charge shall be entitled to do so and recover the cost thereof from the Contractor.
- 29.7 The Contractor shall at his own expense arrange for the safety provisions as required by the Engineer-in-Charge, in respect of all labour directly or indirectly employed for performance of the Works and shall provide all facilities in connection therewith. In case the Contractor fails to make arrangements and provide necessary facilities as aforesaid, the Engineer-in-Charge shall be entitled to do so and recover the cost thereof from the Contractor. But this will not absolve the Contractor of his responsibility or otherwise thereof.
- 29.8 Provided always that the Contractor shall have no right to demand payments/claims whatsoever on account of his compliance with his obligations under this clause and Labour Regulation except those specifically mentioned in the clause 46 pertaining to Price Adjustment/Variation.

CLAUSE 30: REMOVAL OF CONTRACTOR'S MEN

- 30.1 The Contractor shall employ on the execution of the Works only such persons as are skilled and experienced in their respective trades and the Engineer-in-Charge shall be at liberty to object to and require the Contractor to remove from the works any persons employed by the Contractor on the execution of the works who, in the opinion of the Engineer-in-Charge, misconducts himself or is incompetent or negligent in the proper performance of his duties. The Contractor shall forth-with comply with such requisition and such person shall not be again employed upon the works without permission of the Engineer-in-Charge. Any person so removed shall be replaced immediately.

CLAUSE 31: MATERIALS OBTAINED FROM EXCAVATION AND TREASURE, TROVE, FOSSILS ETC.

- 31.1 Materials of any kind obtained from excavation on the site shall remain the property of the Employer and shall be disposed off as directed by the Engineer-in-Charge.
- 31.2 However, if any of the materials except stone thus obtained from excavation on the site is such as can be used in the execution of the work under the contract, the Contractor will be allowed to use the same free of cost (except that any amount of royalty, levies are paid by the Contractor) for the aforesaid purposes provided the same is found suitable and is approved by

the Engineer-in-Charge.

- 31.3 Fossils, coins, articles of value, structures and other remains or things of geological or archeological interest discovered on the site shall be the absolute property of the Employer. The Contractor shall take reasonable precautions to prevent his labour or any other person from removing or damaging any such article or thing and shall immediately upon the discovery thereof and before removal acquaint the Engineer-in-Charge with such discovery and carry out the Engineer-in-Charge's directions as to the disposal of the same at the expense of the Employer.

CLAUSE 32: FORCE MAJEURE

- 32.1 The term "Force Majeure" shall herein mean riots (other than among the Contractor's employees), Civil Commotion (to the extent not insurable), war (whether declared or not), invasion, act of foreign enemies, hostilities, civil war, rebellion, revolution, insurrection, military or usurped power, damage from aircraft, nuclear fission, acts of God, such as earthquake (above 7 magnitude on Richter Scale), lightning, unprecedented floods, fires not caused by Contractor's negligence and other such causes over which the Contractor has no control and are accepted as such by the Engineer-in-Charge, whose decision shall be final and binding. In the event of either party being rendered unable by Force Majeure to perform any obligation required to be performed by them under this contract, the relative obligation of the party affected by such Force Majeure shall be treated as suspended for the period during which such Force Majeure cause lasts, provided the party alleging that it has been rendered unable as aforesaid, thereby shall notify within 10 days of the alleged beginning and ending thereof giving full particulars and satisfactory evidence in support of such cause.
- 32.2 On occurrence of Force Majeure, the liability of either party shall be dealt with, in accordance with the provisions of sub-clause 34.2
- 32.3 Should there be a request for extension of time arising out of "Force Majeure" the same shall be considered in accordance with clause 39.

CLAUSE 33: LIABILITY FOR DAMAGE, DEFECTS OR IMPERFECTIONS AND RECTIFICATIONS THEREOF

- 33.1 If the Contractor or his labour or sub-Contractor injure, destroy or damage roads, fence enclosures, water pipes, cables, buildings, drains, electricity or telephone posts, wires, trees, grass line, cultivated land in the area in which they may be working or in the areas contiguous to the premises on which the work or any part of it is being executed or if any damage is caused during the progress of work, the Contractor shall upon receipt of a notice in writing in that behalf from the Engineer-in-Charge, make the same good at his costs.
- 33.2 If it appears to the Engineer-in-Charge or his representative at any time during construction or reconstruction or prior to the expiration of the Defects Liability period that any work has been executed with unsound, imperfect or unskilled workmanship or that any materials or articles provided by the Contractor for execution of the Works are unsound or of inferior quality, or otherwise not in accordance with the Contract, or that any defect, shrinkage or other faults found in the work arising out of defective or improper materials or workmanship, the Contractor shall, upon receipt of a notice in writing in that behalf from the Engineer-in-Charge, forthwith rectify or remove and reconstruct the work so specified in whole or in part, as the case may be, and/or remove the materials/articles so specified and provide other proper and suitable materials at his own expense.
- 33.3 If the Contractor fails to rectify, make good or remove and reconstruct the work as notified

herein above, the Engineer-in-Charge shall have power to carry out such damages, defects or imperfections by any means or through any other agency or by himself at the risk and cost of the Contractor. In such a case the value of such rectification/replacement, reconstruction through such agencies shall be recovered from the Contractor from any amount due to him. The decision of Engineer-in-Charge in this regard shall be final and binding on the Contractor.

CLAUSE 34: CONTRACTOR'S LIABILITY AND INSURANCE

34.1 **From commencement to completion of the Work(s)** as a whole, the Contractor shall take full responsibility for the care thereof of work and for taking precautions to prevent any loss or damage. He shall be liable for any damage or loss that may happen to the Works or any part thereof and to the Employer's Plant, Equipment and Material (hired or issued to the Contractor). Any such loss or damage shall be restored in good order and condition and in conformity in every respect with the requirements of the Contract and instructions of the Engineer-in-Charge.

34.2 (i) Neither party to the Contract shall be liable to the other in respect of any loss or damage which may occur or arise out of "Force Majeure" to the Works or any part thereof or to any material or article at site but not incorporated in the Works or to any person or anything or material whatsoever of either party provided such a loss or damage could not have been foreseen or avoided by a prudent person and the either party shall bear losses and damages in respect of their respective men and materials. Liability of either parties shall include claims/compensation of the third party also.

(ii) Provided, however, in an eventuality as mentioned in sub-clause 34.2 (i) above, the following provisions shall also have effect:

(a) The Contractor shall, as may be directed in writing by the Engineer-in-Charge proceed with the erection and completion of the works under and in accordance with the Contract; and

(b) The Contractor shall, as may be directed in writing by the Engineer-in-Charge, re-execute the works lost or damaged, remove from the site any debris and so much of the works as shall have been damaged and carry the Employer's T&P, Equipment, Material etc. to the Employer's stores.

Provided always that the Contractor shall, at his own cost, repair and make good so much of the loss or damage as has been by any failure on his part to perform his obligations under the Contract or not taking precautions to prevent loss or damage or minimize the amount of such loss or damage.

34.3 The Contractor shall indemnify and keep indemnified the Employer against all losses and claims for death, injuries or damage to any person or any property whatsoever which may arise out of or in consequence of the construction and maintenance of works during the Period for Completion for whole of the works and also against all claims, demands, proceedings, damages, costs, charges and expenses whatsoever in respect of or in relation thereto, and such liabilities shall include claims/compensations of the third party.

34.4 The Contractor shall avail 'group personal accident insurance policy' covering all the personnel employed by the Contractor for execution for Works complying requirement of Workmen Compensation Act applicable in Nepal. The minimum cover for personal injury or death insurance shall, however, be not less than as per requirements of the Labour Act of

Nepal.

- 34.5 The Contractor shall provide, in the joint names of the Employer and the Contractor, insurance cover for an amount equal to 125% of the Contract Price/Award Value, from the Start Date to the end of the Defects Liability Period for the following events which are due to the Contractor's risks for any reasons whatsoever:
- a. Loss of or damage to the Works, Plant and Materials;
 - b. Loss of or damage to Equipment;
 - c. Loss of or damage to property (except the Works, Plant, Materials and Equipment) in connection with the Contract; and
 - d. Personal injury or death.

The policy shall cover all physical loss or damage to the facilities and works at the Site, occurring prior to completion of the works/facilities, with extended maintenance coverage for the Contractor's liability in respect of any loss or damage occurring during the defect liability period while the Contractor is on the Site for the purpose of performing its obligations during the defect liability period.

- 34.6 Policies and certificates for insurance shall be delivered by the Contractor to the Engineer-in-Charge for the Engineer-in-Charge's approval before the Start Date. All such insurance shall provide for compensation to be payable in the types and proportions of currencies required to rectify the loss or damage incurred.
- 34.7 Alterations to the terms of insurance shall not be made without the approval of the Engineer-in-Charge.
- 34.8 Both parties shall comply with any conditions of the insurance policies.
- 34.9 The Employer shall be named as co-insured under all insurance policies taken out by the Contractor except for the Third Party Liability, Workers' Compensation and Employer's Liability Insurances, and the Contractor's Subcontractors shall be named as co-insured's under all insurance policies taken out by the Contractor. All insurers' rights of subrogation against such co-insured's for losses or claims arising out of the performance of the Contract shall be waived under such policies.

CLAUSE 35: SUSPENSION OF WORKS:

- 35.1 The Contractor shall on the order of the Engineer-in-Charge suspend the progress of the works or any part thereof for such time or times and in such manner as the Engineer-in-Charge may consider necessary and shall during such suspension properly protect and secure the work so far as is necessary in the opinion of the Engineer-in-Charge. If such suspension is:
- (a) provided for in the Contract, **or**
 - (b) necessary for the proper execution of the Works or by reason of weather conditions or by some default on the part of the Contractor, **or**
 - (c) necessary for the safety of the Works or any part thereof.

The Contractor shall not be entitled to extra costs (if any) incurred by him during the period of suspension of the works; but in the event of any suspension ordered by the Engineer-in-Charge for reasons other than aforementioned and when each such period of suspension exceeds 14 days, the Contractor shall be entitled to such extension of Time for Completion of the Works as the Engineer-in-Charge may consider proper having regard to the period or periods of such suspensions and to such compensation as the Engineer-in-Charge may

consider reasonable in respect of salaries or wages paid by the Contractor to his employees during the periods of such suspension.

- 35.2 If the progress of works or any part thereof is suspended on the order of the Engineer-in-Charge for more than three months at a time the Contractor may serve a written notice on the Engineer-in-Charge requiring permission within 15 days from the receipt thereof to proceed with the Works or that part thereof in regard to which progress is suspended and if such permission is not granted within that time the Contractor by a further written notice so served may (but is not bound to) elect to treat the suspension where it affects part only of the Works as an omission of such part or where it affects the whole of the Works as an abandonment of the Contract by the Employer.

CLAUSE 36: FORECLOSURE OF CONTRACT IN FULL OR IN PART DUE TO ABANDONMENT OR REDUCTION IN SCOPE OF WORK

- 36.1 If at any time after acceptance of the tender the Employer decides to abandon or reduce the scope of the Works for reason whatsoever and hence does not require the whole or any part of the Works to be carried out, the Engineer-in-Charge shall give notice in writing to that effect to the Contractor, and the Contractor shall have no claim to any payment of compensation or otherwise whatsoever, on account of any profit or advantage which he might have derived from the execution of the Works in full but which he could not derive in consequence of the fore-closure of the whole or part of the Works.

The Contractor shall be paid at Contract rates for full amount of the Works executed at Site and, in addition, a mutually agreed reasonable amount as certified by the Engineer-in-Charge for the items hereunder mentioned which could not be utilized on the Works to the full extent because of the foreclosure:

- (a) Any expenditure incurred on preliminary works, e.g. temporary access roads, temporary labour huts, staff quarters and site office; storage accommodation workshop, installation and dismantling of Construction Equipment (batching plant, crushing plant) and water storage tanks.
- (b) (i) The Employer shall have the option to take over Contractor's materials or any part thereof, either brought to site or of which the Contractor is legally bound to accept delivery from suppliers (for incorporation in or incidental to the Work), provided, however, the Employer shall be bound to take over the material or such portions thereof as the Contractor does not desire to retain. The cost shall, however, take into account purchase price, cost of transportation and deterioration or damage which may have been caused to materials whilst in the custody of the Contractor.
 - (ii) For Contractor's materials not retained by the Employer, reasonable cost of transporting such materials from Site to Contractor's permanent stores or to his other Works, whichever is less. If materials are not transported to either of the said places, no cost of transportation shall be payable.
- (c) If any materials issued by the Employer are rendered surplus, the same except normal wastage for the materials used in the works shall be returned by the Contractor to the Employer.
- (d) Reasonable compensation for transfer of T&P from Site to Contractor's permanent stores or to his other works whichever is less. If T&P are not transported to either of the said places, no cost of outward transportation shall be payable.

- 36.2 The Contractor shall, if required by the Engineer-in-Charge, furnish to him books of account, wage books, time sheets and other relevant documents as may be necessary to enable him to

certify the reasonable amount payable under this condition.

- 36.3 In the event of foreclosure of the Contract, the advances released to the Contractor shall be recovered/adjusted by en-cashing Bank Guarantees submitted by the contractor against the advances, in appropriate proportion as due to the Employer.

CLAUSE 37: TERMINATION OF CONTRACT ON DEATH:

- 37.1 If the Contractor is an individual or a proprietary concern and the individual or the proprietor dies, or if the Contractor is a partnership concern and one of the partners dies, then, unless the Engineer-in-Charge is satisfied that the legal representatives of the individual Contractor or of the proprietor of the proprietary concern and in the case of partnership, the surviving partners are capable of carrying out and completing the Contract, the Engineer-in-Charge shall be entitled to terminate the Contract as to its uncompleted part without the Employer being in any way liable to payment of any compensation whatsoever on any account to the estate of the deceased Contractor and/or to the surviving partners of the Contractor's firm on account of termination of the Contract. The decision of the Engineer-in-Charge that the legal representatives of the deceased Contractor or the surviving partners of the Contractor's firm cannot carry out and complete the Works under the Contract shall be final and binding on the parties. In the event of such termination, the Corporation shall not hold the estate of the deceased Contractor and/or the surviving partners of the Contractors firm liable for damages for not completing the Contract. Provided that the power of the Engineer-in-Charge of such termination of contract shall be without prejudice to any other right or remedy, which shall have accrued or shall accrue to him under the Contract.

CLAUSE-38: DEFAULT BY THE CONTRACTOR AND TERMINATION OF CONTRACT IN FULL OR IN PART:

38.1 If the Contractor:

- i) commits default in complying with or commits breach of any of the conditions of the Contract and does not remedy it or take effective steps to remedy it immediately after a notice in writing is given to him by the Engineer-in-Charge; or
- ii) fails to complete the Works or any item of Works within the time specified in Schedule 'C' or any extended time under the Contract and does not complete the Work(s) or any item of Work(s) within the period specified in a notice given in writing by the Engineer-in-Charge; or
- iii) is engaged in corrupt or fraudulent practices in competing for or in the execution of the Contract. For the purpose of this clause
 - a) 'Corrupt Practice' means offering, giving, receiving or soliciting of anything of value to influence the action of a public official in the procurement or execution of Contract.
 - b) 'Fraudulent Practice' means mis-representation of fact in order to influence the tendering process or the execution of a Contract and includes collusive practice among bidders (prior to or after bid submission) designed to establish bid prices at artificial non-competitive levels and to deprive the employer of the benefits of free and open competition.
- iv) being an individual, or if a firm, any partner thereof, shall at any time be adjudged insolvent or have a receiving order or order for administration of his estate made against him or shall take any proceedings for liquidation for the purpose of amalgamation or

reconstruction under any insolvency Act for the time being in force or make any conveyance or assignment of his effective or composition or arrangement for the benefit of his creditors or purport as to do, or if any application be made under any insolvency Act for the time being in force for the sequestration of his estate or if a trust deed be executed by him for benefit of his creditors; or

- v) being a company shall pass a resolution or the Court shall make an order for the liquidation of its affairs or a receiver or manager on behalf of the debenture holders shall be appointed or circumstances shall arise which entitle the Court or debenture holders to appoint a receiver or manager; or
- vi) shall suffer an execution in an execution being levied on his goods; or
- vii) assigns, transfers, sublets (engagement of labour on a piece-work basis or of labour with materials not being incorporated in the work shall not be deemed to be subletting) or attempts to assign, transfer or sublet the entire works or any portion thereof without the prior written approval of the Engineer-in-Charge.

The Engineer-in-Charge shall have powers to terminate the Contract in full or in part as aforesaid without prejudice to any other right or remedy which shall have accrued or shall accrue of which cancellation notice in writing to the Contractor under the hand of the Engineer-in-Charge shall be conclusive evidence.

- 38.2 The Engineer-in-Charge shall, on such termination of the contract, have powers to take possession of the site of work under the contract as well as the land/premises allotted to the Contractor for his preliminary, enabling and ancillary works and any materials, constructional equipment, implements, stores, structures etc. thereon. The Engineer-in-Charge shall also have powers to carry out the incomplete work by any means or through any other agency or by himself at the risk and cost of the Contractor. In such a case, the value of the work done through such agencies shall be credited to the Contractor at the contract rate and the Contractor shall pay the excess amount, if any, incurred in completing the work as aforesaid, as stipulated under sub-clause 38.4 hereunder.
- 38.3 On termination of the Contract in full or in Part, the Engineer-in-Charge may direct that a part or whole of such plant, equipment and materials, structures be removed from the site of the work as well as from the land/premises allotted to the Contractor for his preliminary, enabling and ancillary works, within a stipulated period. If the Contractor shall fail to do so within the period specified in a notice in writing by the Engineer-in-Charge, the Engineer-in-Charge may cause them to be sold, holding the net proceeds of such sale to the credit of the Contractor, which shall be released after completion of works and settlement of amounts under the Contract.
- 38.4 If the expenses incurred or to be incurred by the Employer for carrying out and completing the incomplete work or part of the same, as certified by the Engineer-in-Charge, are in excess of the value of the work credited/to be credited to the Contractor, the difference shall be paid by the Contractor to the Employer. If the Contractor fails to pay such an amount, as aforesaid, within thirty days of receipt of notice in writing from the Engineer-in-Charge, the Engineer-in-Charge shall recover such amount from any sums due to the Contractor on any account under this or any other contract or from his Security Deposit or otherwise.
- 38.5 The Engineer-in-Charge shall have the right to sell any or all the Contractor's unused materials, constructional equipment, implements, temporary buildings/structures etc. and apply the proceeds of sale thereof towards the satisfaction of any sums due from the Contractor under the Contract and if thereafter there may be any balance outstanding from

the Contractor, the Engineer-in-Charge shall have powers to recover the same as debt.

38.6 All decisions/actions of the Engineer-in-Charge under this clause, as aforesaid, shall be conclusive and binding on the Contractor.

CLAUSE 39: TIME FOR COMPLETION AND EXTENSIONS:

39.1 Time for Completion allowed for execution of the Works is as specified in Schedule 'B' of these conditions.

39.2 However, if the work is delayed on account of:

- i) Delay in handing over of site to the Contractor as per clause 12; or
- ii) Increase in the quantity of work to be done under the Contract as per clause 18; or
- iii) Suspension of work as per clause 35; or
- iv) Rebuilding of work as per clause 34; or
- v) "Force Majeure" as per clause 32 or
- vi) Unforeseeable shortage in the availability in the availability of personnel or goods caused by epidemic or Government actions.
- vii) Any other cause which, in the opinion of the Engineer-in-Charge is beyond the Contractor's control;

then, immediately upon the happening of any such event as aforesaid, the Contractor shall inform the Engineer-in-Charge accordingly, but the Contractor shall nevertheless use constantly his best endeavors to prevent and/or make good the delay and shall do all that may be required in this regard. No extension in time on account of rains shall be admissible. The Contractor shall request, in writing, for extension of time, to which he may consider himself eligible under the Contract, within fourteen days of the date of happening of any such events as indicated above.

Provided further that no monetary claims shall be admissible to the Contractor for such Extension of Time for Completion except for Price Adjustment in accordance with clause-46 and reimbursement of cost of extension of bank guarantee for Security Deposit (i.e. Performance security deposit and retention money) and Insurance Policy(ies).

39.3 In any such case as may have arisen due to any of the events, as aforesaid, and which shall be brought out by the Contractor in writing, the Engineer-in-Charge may give a fair and reasonable extension of Time for Completion, after taking into consideration the nature of the work delayed and practicability of its execution during the period of extension. Provided in the event of non-receipt of a request for such extensions from the Contractor for reasons whatsoever, the Engineer-in-Charge may, at his sole discretion and with due regard to the event, grant fair and reasonable extension of time sue motto.

Such extensions, if admissible, shall be communicated to the Contractor by the Engineer-in-Charge in writing.

Provided that Engineer-in-Charge is not bound to make any determination unless the Contractor has;

- a) within 14 days after such event has first arisen notified the Engineer and
- b) within 28 days or such other reasonable time as may be agreed by the Engineer-in-Charge detailed particulars of any extension of Time for Completion to which the Contractor may consider himself entitled.

CLAUSE 40: COMPENSATION FOR DELAY

- 40.1 If the Contractor fails to complete all items of work(s) in respect of any of Milestone and/or Work as a whole, as the case may be and as specified in SCC before the expiry of the period(s) of completion as stipulated in the aforesaid Schedule or any extended period under Clause 39 as may be allowed, he shall without prejudice to any other right or remedy of the Employer on account of such default, pay as an ascertained/agreed compensation (Liquidated Damages) not by way of penalty; such amount as stipulated in the aforesaid in SCC.
- 40.2 The amount of Liquidated Damages /compensation may be adjusted/withheld/ deducted or set-off against any sum due or payable to the Contractor under this or any other contract with the Employer. The payment or deduction of such damages shall not relieve the Contractor from his obligation to complete the Works or from any other obligations and liabilities under the Contract
- 40.3 Should, however, the Contractor achieve the completion of the Works as a whole under the Contract within the time as stipulated in Schedule `B' or in the extended time as may be accorded, the Employer will refund to him the amount of compensation recovered from him, if any, in respect of delay in the non-completion of work(s) under the individual Milestone, as aforesaid in full. However, no interest on refund of amount of compensation as above shall be payable to the Contractor.
- 40.4 In case the compensation for delay (Liquidated Damages) are levied on account of delay in preceding Milestones and if contractor achieves the next milestone within the specified schedule (as mentioned in SCC) and also achieves all the delayed preceding Milestones by that date, then the compensation already levied for all delayed preceding Milestones shall be refunded in next payment. However, no interest on refund of delay damages as above shall be payable to the contractor.

CLAUSE 41: INSPECTION AND APPROVAL

- 41.1 All works embracing more than one process shall be subject to examination and approval at each stage thereof and the Contractor shall give due notice to the Engineer-in-Charge or his authorized representative, when each stage is ready. In default of such notice, the Engineer-in-Charge shall be entitled to appraise the quality and extent thereof and the decision of the Engineer-in-Charge in this regard shall be final and binding.
- 41.2 No work shall be covered or put out of view without the approval of the Engineer-in-Charge or his authorized representative and the Contractor shall afford full opportunity for examination of foundations before permanent work is placed thereon. The Contractor shall give due notice to the Engineer-in-Charge or his authorized representative whenever any such work or foundation is ready for examination and the Engineer-in-Charge or his representative shall, without unreasonable delay, unless he considers it unnecessary and advises the Contractor accordingly, examine and measure such work or such foundations. In the event of the failure of the Contractor to give such notice, he shall, if required by the Engineer-in-Charge, uncover such work at the Contractor's expense.
- 41.3 The Engineer-in-Charge or his representative shall have powers at any time to inspect and examine any part of the Works and Contractor shall give such facilities as may be required for such inspection and examination.
- 41.4 The Contractor shall uncover any part of the works and/or make opening in or through the same as the Engineer-in-Charge may from time to time direct for his verification and shall reinstate and make good such part to the satisfaction of the Engineer-in-Charge. If any such part has been covered up or put out of view after being approved by the Engineer-in-Charge

and is subsequently found, on uncovering, to be executed in accordance with the Contract, the expenses of uncovering and/or making openings in or through, reinstating and making good the same, shall be borne by the Employer. In any other causes all such expenses shall be borne by the Contractor.

CLAUSE 42: COMPLETION CERTIFICATE:

- 42.1 The Work shall be completed to the entire satisfaction of the Engineer-in-Charge and in accordance with the time schedule mentioned in Schedule 'B' and terms and conditions mentioned in Clause-39. As soon as the Works under the Contract is completed as a whole, the Contractor shall give notice of such completion to the Engineer-in-Charge. The Engineer-in-Charge, within two week of receipt of such notice, shall inspect the Work and shall satisfy himself that the Work(s) has been completed in accordance with the provisions of the Contract and then issue to the Contractor a certificate of completion indicating the date of completion. Should the Engineer-in-Charge notice that there are defects in the Works or the Works are not considered to be complete, he shall issue a notice in writing to the Contractor to rectify/replace the defective Work or any part thereof or complete the work, as the case may be, within such time as may be notified and after the Contractor has complied with as aforesaid and gives notice of completion, the Engineer-in-Charge shall inspect the Work and issue the completion certificate in the same manner as aforesaid.
- 42.2 No certificate of completion shall be issued as stipulated under 42.1 above nor Work be considered to be completed unless the Contractor shall have removed from the Work site and/or premises all his belongings/temporary arrangements brought/made by him for the purpose of execution of the work and clean the site and/ or premises in all respects and made the whole of the site and or premises fit for immediate occupation/ use to the satisfaction of the Engineer-in-Charge. If the Contractor fails to comply with the above mentioned requirements on or before the date of completion of the Work, the Engineer-in-Charge, may, as he thinks fit and at the risk and cost of the Contractor, fulfill such requirements and remove/ dispose-off the Contractor's belongings/ temporary arrangements, as aforesaid, and the Contractor shall have no claim in this respect except for any sum realized by the sale of Contractor's belongings/ temporary arrangements less the cost of fulfilling the said requirements and any other amount that may be due from the Contractor. Should the expenditure on the aforesaid account exceed the amount realized by sale of such Contractor's belongings/ temporary arrangements than the Contractor shall on demand, pay the amount of such excess expenditure.

CLAUSE 43: DEFECTS LIABILITY PERIOD

- 43.1 The "Defects Liability Period" for the entire work under the Contract shall be 365 days from the completion date of work.
- 43.2 If during the Defects Liability Period any portion of the Works is found defective or deficient in any manner and is repaired/rectified/replaced pursuant to the defects liability provisions of the Contract, the Defects Liability Period for such portion of the Works, shall, notwithstanding anything to contrary contained herein, be operative for a further period of 6 months from the date of such repair/rectification/ replacement but shall not in any case be operative for more than 18 months from the date of completion stated in the Completion Certificate.

CLAUSE 44: MEASUREMENTS

- 44.1 The Engineer-in-Charge shall, except as otherwise stated ascertain and determine by

measurement, the value of work done in accordance with the Contract.

- 44.2 Notwithstanding any provision in the relevant standard method of measurement or any general or local custom, measurement of work done under the Contract shall be taken in accordance with the procedure set forth in the Technical Specifications or Bill of Quantities under the Contract. In the case of items of Work, which are not covered by the Technical Specifications or Bill of Quantities, measurement shall be taken in accordance with the relevant standard methods of measurements laid down by the Bureau of Indian Standards (BIS).
- 44.3 All items having a financial value shall be entered in measurement book, level book, etc., prescribed by the Employer so that a complete record is maintained of all work performed under the Contract.
- 44.4 Measurement shall be taken jointly by the Engineer-in-Charge or his representative and by the Contractor or his authorized representative.
- 44.5 Before taking measurement of any works, the Engineer-in-Charge or his representative, shall give a reasonable notice to the Contractor. If the Contractor fails to attend or send an authorized representative for measurement after such a notice or fails to countersign or to record the objection within a week from the date of taking the measurements, then in that event the measurements taken by the Engineer-in-Charge shall be taken to be correct and final measurements of such work.
- 44.6 The Contractor shall, without extra charge, provide assistance with every appliance, labour and other appliances (theodolite, level etc.) and things necessary for measurement.
- 44.7 Measurement shall be signed and dated by both parties on the Site on completion of measurement. If the Contractor objects to any of the measurements recorded by the representative of the Engineer-in-Charge, a note to that effect shall be made in the measurement book against the item objected to and such note shall be signed and dated by both parties engaged in taking the measurement. The decision of the Engineer-in-Charge on any such dispute or difference or interpretation shall be final and binding on the Contractor in respect of all contract items, substituted items, extra items and deviations. Provided that items of Work which are not susceptible to measurement at the later date must be measured jointly and signed accordingly by both the parties at the time of execution of such items.

CLAUSE 45: PAYMENT ON ACCOUNT

- 45.1 Running Account / Interim bills shall be submitted by the Contractor in accordance with the payment terms specified in the Special Conditions of Contract for the work executed after compliance of all statutory provisions and complete in terms of contract conditions. The Engineer-in-Charge shall then verify the bills with reference to the measurements recorded in the measurement book(s).
- 45.2 Payment on account for amount admissible shall be made on the Engineer-in-Charge certifying the sum to which the Contractor is considered entitled by way of interim payment for the work executed, after deducting there from the amounts already paid, the Retention Money, Statutory Deductions (if any) and such other amounts as may be withheld/deductible or recoverable in terms of the Contract.
- 45.3 Payment of the Contractor's bills shall be made by the Employer within 30 days from the date of submission of the bill subject to the acceptance of the Engineer-in-Charge and in accordance with clause 45.8

- 45.4 Payments due to the Contractor shall be made through cheque or electronic mode for which the Contractor will provide the complete bank details viz. Beneficiary's name, account no., Bank name and address of bank, RTGS code etc. to the Engineer-in-Charge or his representative.
- 45.5 Any interim bills given relating to work done or materials delivered, may be modified or corrected by any subsequent interim bills or by the final bill. No certificate(s) of the Engineer-in-Charge supporting an interim payment shall itself be conclusive evidence that any work or materials to which it relates is/are in accordance with the Contract.
- 45.6 Should there be a request for Extension of Time for completion, pending its consideration; interim payments shall continue to be made as provided herein. Such payment shall be without prejudice to right of the Employer to levy Liquidated Damages on the Contractor in terms of provisions of Contract.
- 45.7 In case of disputed items for which payment has been withheld, the Engineer-in-Charge will intimate to the Contractor in writing the details of such disputed items. The Contractor shall submit in writing the clarifications / modifications in regard to this disputed item to the Engineer-in-Charge. After such clarifications / modifications and acceptance thereof by the Engineer-in-Charge, payment of such disputed items shall be released within 30 days thereafter. **No interest shall be paid for the disputed amounts of items till the same is resolved and accepted by Engineer-in-charge as above. In case of delay in payments for undisputed bill beyond the stated period of 30 days an interest @ 5% per annum simple interest shall be payable.**
- 45.8 *Deleted without change in Sr. No.*

CLAUSE 46: PRICE ADJUSTMENT/VARIATIONS: Not Applicable (Clause deleted i.e. Sr. No. 46.1 to 46.6)

CLAUSE 47: TAXES, DUTIES AND LEVIES ETC:

- 47.1 All existing taxes such as VAT, customs duty, Import duty, business taxes, service tax or Income tax or any other tax or duty or levy such as Octroi, Dharat, Royalty, Terminal tax that may be levied in accordance with laws and regulation in force as on 28 days before the last date of submission of price bid that the Contractor has to pay on the Contractor's equipment, plant, materials and supplies (permanent, temporary and consumables) acquired for the purpose of the Contract and for the services performed under the Contract shall be exclusively payable by the Contractor, and the Employer shall not entertain any claim in this regard. **The rate quoted by the Contractor shall be deemed to be inclusive of all such taxes, duties and levies etc. including VAT.** However, payment in respect of taxes will be regulated in terms of statutory provisions prevailing while releasing the same. Any statutory variation in the rate of aforesaid taxes if any, during the currency of the Contract including extension thereof shall be to the account of Employer (reimbursed/adjusted) provided the amount thus claimed is not paid under price variation clause 46.
- 47.2 However, if a New Tax or Duty or Levy, other than those existing on 28 days before the last date of submission of price is imposed in Nepal under a statute or law during the currency of the Contract and the Contractor becomes legally liable thereunder to and actually pays the same for bonafide use on the Works contracted, then the Contractor shall immediately inform the Engineer-in-Charge in this regard. The Employer will reimburse/adjust the same to the Contractor on production of satisfactory proof of payment, provided that the amount thus

claimed is not paid under Price variation clause 46 of General Conditions of the Contract. Changes in the advance tax rates of Income Tax payable to appropriate authorities shall not be construed as a change in the rate(s) of taxes and will not be subject to adjustment.

- 47.3 The Contractor's staff and labor will be liable to pay personal income taxes in respect of such of their salaries and wages as are chargeable under the laws and regulations for the time being in force, and the Contractor shall perform such duties in regard to such deductions thereof as may be imposed on him by such laws and regulations.
- 47.4 The Project is entitled to 50% exemption on Custom duty as prevailing on import of cement, Iron & steel product, subject to compliance of certain conditions by the Contractor. Contractors are requested to quote the rates keeping in view the concessions available as above.
- 47.5 *Clause deleted.*
- 47.6 As per Project Development Agreement (PDA) SJVN Arun-3 Power Development Company Private limited (SAPDC) has a concession available for import of construction machinery, plant, equipment etc., as per prevailing Laws, Rules & regulations applicable in Nepal. The contractor is required to go through the relevant concession available and quote the rates accordingly.

CLAUSE 48: PAYMENT OF FINAL BILL:

- 48.1 The final bill shall be submitted by the Contractor within one month of the date fixed for completion of the Work or of the date the Certificate of Completion furnished by the Engineer-in-Charge. No further claim in this regard unless as specified herein under shall be entertained. Payment shall be made **within 6 months** of the submission of Final bill. If the payment is not made within 6 months an interest @ 5% per annum simple interest shall be payable on undisputed amount of bill. If there shall be any dispute about any item or items of the work then the undisputed item or items only shall be paid within the said period of six months. The Contractor shall submit a list of the disputed items within thirty days from the disallowance thereof and if he fails to do so, his claim shall be deemed to have been fully waived and absolutely extinguished. Provided further the Employer shall not be liable to the Contractor for any matter or thing arising out of or in connection with the Contract or execution of the Works, unless the Contractor shall have included a claim in respect thereof in his Final Bill. No interest will be paid on disputed amount till the same is resolved and accepted by the Engineer-in-Charge, except that is awarded by Dispute Resolution Mechanism Authority and subjected to its acceptance by the employer. After such acceptance thereof by the Engineer-in-Charge, payment of such disputed items shall be released within 30 days thereafter in accordance with clause 45.7 or otherwise in accordance with the dispute resolution mechanism award accepted for implementation by the Engineer in Charge.

CLAUSE 49: OVER PAYMENT AND UNDER PAYMENT:

- 49.1 Whenever any claim whatsoever for the payment of a sum of money to the Employer arises out of or under this Contract against the Contractor, the same may be deducted by the Employer from any sum then due or which at any time thereafter may become due to the Contractor under this Contract and failing that under any other contract with the Employer or from any other sum whatsoever due to the Contractor from the Employer or from his security deposit, or he shall pay the claim on demand.

- 49.2 The Employer reserve the right to carry out post- payment audit and technical examination of the final bill including all supporting vouchers, abstracts, etc. The Employer further reserves the right to enforce recovery of any overpayment when detected, notwithstanding the fact that the amount of the final bill may be included by one of the parties as an item of dispute before an arbitrator appointed under clause 55 of this Contract and notwithstanding the fact that the amount of the final bill figures in the arbitration award.
- 49.3 If as a result of such audit and technical examination any overpayment is discovered in respect of any work done by the Contractor or alleged to have been done by him under the Contract, it shall be recovered by the Employer from the Contractor by any or all of the methods prescribed above, and if any under- payment is discovered, the amount shall be duly paid to the Contractor by the Employer.
- 49.4 Provided that the aforesaid right of the Employer to adjust overpayments against amounts due to the Contractor under any other contract with the Employer shall not extend beyond the period of two years from the date of payment of the final bill or in case the final bill is a MINUS bill, from the date the amount payable by the Contractor under the MINUS final bill is communicated to the Contractor.
- 49.5 Any sum of money due and payable to the Contractor (including the security deposit (i.e. Performance Security & Retention Money) returnable to him) under the Contract may be withheld or retained by way of lien by the Engineer-in-Charge or Employer against any claim of the Employer or such other person or persons in respect of payment of a sum of money arising out of or under any other contract made by the Contractor with the Engineer-in-Charge or Employer or with such other person or persons.

The sum of money so withheld or retained under this clause by the Engineer-in-Charge or Employer will be kept withheld or retained as such by the Engineer-in- Charge or Employer or till his claim arising out of in the same Contract or any other contract is either mutually settled or determined by the arbitrator under Clause 55 hereof, or by the competent court.

CLAUSE 50: TRAINING OF APPRENTICES: Clause Deleted

CLAUSE 51: CONTRACT MATTERS TO BE TREATED AS CONFIDENTIAL:

- 51.1 All documents, correspondence, decisions and orders concerning the Contract shall be considered as confidential and/or restricted in nature by the Contractor and he shall not divulge or allow access to them by any unauthorized person.

CLAUSE 52: LAWS GOVERNING THE CONTRACT:

- 52.1 Unless otherwise hereinafter provided, this Contract shall be construed, interpreted and governed by laws of Nepal. The laws applicable to the Contract shall be the laws in force in Nepal. **Courts of Chainpur (Nepal) shall have exclusive Jurisdiction for adjudication upon the dispute arising out of the contract between the parties.**

CLAUSE 53: PROCEDURE FOR CLAIMS

- 53.1 Except as otherwise provided in any other provision of the Contract, if the Contractor intends to claim any additional payment pursuant to any Clause of these Conditions or otherwise, he shall give notice of his intention to the Engineer, within 28 days after the event giving rise to

the claim has first arisen.

- 53.2 Upon the happening of the event referred to in Sub-Clause 53.1, the Contractor shall keep such contemporary records as may reasonably be necessary to support any claim he may subsequently wish to make. Without necessarily admitting the Employer's liability, the Engineer-in-Charge shall, on receipt of a notice under Sub-Clause 53.1, inspect such contemporary records and may instruct the Contractor to keep any further contemporary records as are reasonable and may be material to the claim of which notice has been given. The Contractor shall permit the Engineer-in-Charge to inspect all records kept pursuant to this Sub-Clause and shall supply him with copies thereof as and when the Engineer so instructs.
- 53.3 Within 28 days, or such other reasonable time as may be agreed by the Engineer-in-Charge, of giving notice under Sub-Clause 53.1, the Contractor shall send to the Engineer-in-Charge an account giving detailed particulars of the amount claimed and the grounds upon which the claim is based. Where the event giving rise to the claim has a continuing effect, such account shall be considered to be an interim account and the Contractor shall, at such intervals as the Engineer-in-Charge may reasonably require, send further interim accounts giving the accumulated amount of the claim and any further grounds upon which it is based. In cases where interim accounts are sent to the Engineer-in-Charge, the Contractor shall send a final account within 28 days of the end of the effects resulting from the event. The Contractor shall, if required by the Engineer-in-Charge so to do, copy to the Employer all accounts sent to the Engineer-in-Charge pursuant to this Sub-Clause.
- 53.4 The Contractor shall be entitled to have included in any interim payment certified by the Engineer-in-Charge pursuant to Clause 45 such amount in respect of any claim as the Engineer-in-Charge, after due approval of the Employer, may consider due to the Contractor provided that the Contractor has supplied sufficient particulars to enable the Engineer-in-Charge to determine the amount due. If such particulars are insufficient to substantiate the whole of the claim, the Contractor shall be entitled to payment in respect of such part of the claim as such particulars may substantiate to the satisfaction of the Engineer-in-Charge. The Engineer-in-Charge shall notify the Contractor of any determination made under this Sub-Clause.

CLAUSE 54: SUM PAYABLE BY WAY OF COMPENSATION TO BE CONSIDERED AS REASONABLE WITHOUT REFERENCE TO ACTUAL LOSS:

- 54.1 All sums payable by way of compensation to the Employer under any of these conditions shall be considered as reasonable compensation without reference to the actual loss or damage sustained and whether or not damage shall have been sustained.

CLAUSE 55: ARBITRATION

- 55.1 Except as otherwise provided in clause-53.1 above, all questions, dispute or difference in relation to or in connection with the Contract shall be referred for arbitration in the manner provided as under:
- a. Either of the parties may give to the other a notice in writing of the existence of such question, dispute or difference,
 - b. All dispute or difference in respect of which the decision has not been final and conclusive arising between the Contractor and SJVN Arun-3 power Development Company Private Limited in relation to or in connection with the Contract, shall be referred to Arbitration in the manner provided as hereunder:

- (i) Arbitration will be by sole arbitrator. SJVN Arun-3 Power Development Company Private Limited shall appoint and designate one of its officer as a Sole Arbitrator who shall carry out Arbitration proceeding as Sole Arbitrator.
 - (ii) The Arbitrator to whom the matter is originally referred being transferred or vacating his office or being unable to act for any reason, then the SJVN Arun-3 power Development Company Private Limited shall appoint another person to act as sole arbitrator in the same manner as provided herein above. Such person shall be entitled to proceed with the reference from the stage at which it was left by the predecessor.
- c. Subject as aforesaid the provision of the Nepal's Arbitration Act. 2055, or any statutory modification or re-enactment thereof and the rules made there under and for the time being in force shall apply to the arbitration proceeding under this clause.
- d. Irrespective of amount of the claim, Arbitrator shall give reasons for the Award.

55.2 The cost of Arbitration proceedings shall be borne equally by either party.

55.3 Arbitration proceedings shall be held at **Kathmandu, Nepal.**

55.4 The language of the arbitration proceedings and that of all documents and communications between the parties shall be English, however in case of any dispute English version will prevail. The arbitrator shall make a reasoned written award.

55.5 Notwithstanding any reference to the arbitration herein, the parties shall continue to perform their respective obligations under the contract

CLAUSE 56: BREAKDOWN OF LUMP SUM ITEMS

56.1 For the purposes of statements submitted in accordance with Sub-Clause 45, the Contractor shall submit to the Engineer-in-Charge, a breakdown for each of the lump sum items contained in the Tender. Such breakdowns shall be subject to the approval of the Engineer-in-Charge.

CLAUSE 57: DEFECTS LIABILITY PERIOD & UNFULFILLED OBLIGATIONS

57.1 The Contract shall not be considered as completed until a Defects Liability Certificate shall have been signed by the Engineer-in-Charge and delivered to the Contractor, stating the date on which the Contractor shall have completed his obligations to execute and complete the Works and remedy any defects therein to the Engineer-in-Charge's satisfaction. The Defects Liability Certificate shall be given by the Engineer-in-Charge within 28 days after the expiration of the Defects Liability Period.

Notwithstanding the issue of the Defects Liability Certificate the Contractor and the Employer shall remain liable for the fulfillment of any obligation incurred under the provisions of the Contract prior to the issue of the Defects Liability Certificate which remains unperformed at the time such Defects Liability Certificate is issued and, for the purposes of determining the nature and extent of any such obligation, the Contract shall be deemed to remain in force between the parties to the Contract.

CLAUSE 58: ECOLOGICAL BALANCE

The Contractor shall be required to ensure that there shall be no indiscriminate felling of trees by him or his labourers or their family members and he will be solely responsible for their acts in this regard. The Contractor shall try to maintain ecological balance by preventing deforestation, water pollution and defacing of natural landscape in the vicinity of work areas. The Contractor shall so conduct his construction operations as to prevent an unnecessary destruction of, scarring or defacing the natural surroundings in the vicinity of the work area.

In order to maintain the ecological balance, the Contractor shall specifically observe the following instructions:

- a) Where unnecessary destruction, scarring, damage or defacing may occur as a result of the Contractor's operation, the same shall be repaired, replanted or otherwise corrected at the Contractor's expense. The Contractor will prevent scattering of rocks and other debris outside the work areas. All work areas shall be smoothed and graded in a manner to conform to the natural appearance of the landscape as directed by the Engineer-in-Charge.
- b) All trees and shrubs, which are not specifically required to be cleared or removed for construction purposes, shall be preserved and shall be protected from any damage that may be caused by the Contractor's construction operation and equipment. The removal of trees or shrubs will be permitted only after prior approval by the Engineer-in-charge. Special care shall be exercised where trees or shrubs are exposed to injuries by construction equipment, blasting, and excavating, dumping, chemical damage or other operation and the Contractor shall adequately protect such trees by use of protective barriers or other methods approved by the Engineer-in-Charge. Trees shall not be used for anchorage.
- c) The Contractor's construction activities shall be performed by methods that will prevent entrance or accidental spillage of solid matter contaminants, debris and other objectionable pollutants and wastage into river. Pollutants and wastes shall be disposed of in a manner and at sites approved by the Engineer in-Charge. The Contractor shall fully comply with Water (Prevention and Control of Pollution) Act, 1974 section -33(A) or as applicable in Nepal.
- d) In the Conduct of construction activities and operation of equipment, the Contractor shall utilize such practicable methods and devices as are reasonably available to control, prevent and otherwise minimize air pollution. The Contractor shall fully comply with Air (Prevention and Control of Pollution) Act, 1981 section -31(A)/ Environment Protection Act, 2053 (1997 A.D.), Nepal.

Burning of materials resulting from clearing of tree, bush, combustible construction materials and rubbish may be permitted only when atmospheric conditions for burning are considered favourable.

Separate payment will not be admissible to the Contractor for complying with the provisions of this clause and all costs shall be deemed to have been included in the items mentioned in the Bill of Quantities. If any provision(s) is not complied with, within a reasonable time even after issue of a notice in this respect, the necessary operations would be carried out by the Engineer-in-charge at the cost of the Contractor.

CLAUSE 59: GENERAL

59.1 Save and except as expressly provided elsewhere in this Contract all costs, expenses, charges

and liabilities for the completion of the Works in accordance with the Contract and/or for the due and faithful performance and/or the fulfillment of all of the Contractor's obligations under the Contract including furnishing of bank guarantees to the Employer pursuant to the Contract shall be to the account of and be borne by the Contractor and shall be deemed to be included in the unit rates provided for in the Bill of Quantities and the Employer shall not be liable in any manner whatsoever therefore.

- 59.2 Whenever any claim whatsoever for the payment of a sum of money to the Employer arises out of or under this contract against the Contractor, the same may be deducted by the Employer from any sum then due or which at any time thereafter may become due to the Contractor under this Contract and failing, that under any other contract between the Employer and the Contractor or from any other sum whatsoever due to the Contractor from the Employer or from his Security Deposit or he shall pay the claim on demand.

CLAUSE 60: CONTRACTOR'S NEAR RELATIVES EMPLOYED IN SJVN/SJVN ARUN-3 POWER DEVELOPMENT COMPANY PRIVATE LIMITED.

- 60.1 The Contractor shall not be permitted to tender for works if any of his near relative who is employed as Accountant or Officer in any capacity between the grades of Executive Director and Assistant Engineer (both inclusive) and responsible for award and execution of contract in the SJVN Ltd/ SJVN Arun-3 power Development Company Private Limited. He shall also intimate the names of the persons who are working with him in any capacity or are subsequently employed by him and who are near relatives of any officer of SJVN Ltd/ SJVN Arun-3 power Development Company Private Limited.

Note: By the term relatives is meant wife, husband, parents, children and grand-children, brothers and sisters, uncles and cousins and their corresponding in laws.

CLAUSE 61: RETIRED GOVT SERVANTS TAKING UP CONTRACT

- 61.1 No Engineer of gazetted rank or other gazetted Officer/Executives employed in Engineering or Administrative duties in a Engineering Department of State Government/SJVN/SJVN Arun-3 power Development Company Private Limited or the Government of India is allowed to work as a Contractor for a period of two years of his retirement from Government service without the permission of State Government or Government of India. The contract is liable to be cancelled if either of Contractors or any of his employees is found at any time to be such a person who had not obtained the permission of State Government or Government of India as aforesaid, before submission of the tender or engagement in the Contractor's service as the case may be.

SECTION V

CONTRACT FORMS

- 1. FORM OF BANK GUARANTEE FOR EARNEST MONEY DEPOSIT AND INSTRUCTIONS TO BE FOLLOWED FOR EXECUTION OF ALL KIND OF BANK GUARANTEES**
- 2. FORM OF BANK GUARANTEE FOR PERFORMANCE SECURITY DEPOSIT**
- 3. PERFORMA FOR AGREEMENT**

INSTRUCTIONS TO BE FOLLOWED FOR EXECUTION OF ALL KINDS OF BANK GUARANTEES

1. Bank Guarantee should be executed on papers of requisite value in accordance with the Stamp Act as applicable in Nepal.
2. The executing officers of the Bank Guarantee shall clearly indicate in (Block Letters), his name, designation, Power of Attorney No./Signing Power No. etc.
3. Each page of the Bank Guarantee shall be duly signed / initialed by the executing officers and the last page shall be signed in full, indicating the particulars as aforesaid (sub-para2) under the seal of the Bank.
4. The original Bank Guarantee should be sent by the Bank to SJVN Arun-3 Power Development Company Private limited directly under Regd. Post (A.D.). However, in exceptional cases, where the original BG is handed over to the bidder by the issuing bank/branch, the bidder shall ensure that an un-stamped duplicate copy of the BG has been sent immediately by the issuing bank/branch under Regd. Post (A.D.) directly to SJVN Arun-3 Power Development Company Private limited with a covering letter to compare with original BGs and confirm that it is in order.

1. FORM OF BANK GUARANTEE FOR EARNEST MONEY DEPOSIT

(Refer clause 14.0 of ITB)

WHEREAS _____ (Name of Bidder) (hereinafter called “the Bidder”) has submitted his bid dated _____ (date) for “Improvement of Katwaldada to Lumbang Road (RD 0.00 to 1.479 km), Makalu RM-05, Num, Distt. Sankhuwasabha, Nepal under Local Benefit Sharing Plan (LBSP) of Arun-3 Hydro Electric Project (900 MW).”

SEALED with the Common Seal of the said Bank this ____ day of _____ (Month and Year).

THE CONDITIONS of this obligation are:

1. If after Bid opening the Bidder withdraws his Bid during the period of bid validity specified in the Form of Bid or
2. If the Bidder having been notified of the acceptance of his Bid by the SJVN Arun-3 Power Development Company Private Limited, during the period of bid validity.
 - a. fails or refuses to execute the Form of Agreement in accordance with the Instructions to Bidders, if required; or
 - b. fails or refuses to furnish the Performance Security, in accordance with the Instructions to Bidders, or
 - c. does not accept the correction of the Bid Price pursuant to **Clause-24.0 of ITB.**
 - d. adopts corrupt or fraudulent practices

we undertake to pay to the SJVN Arun-3 Power Development Company Private Limited, NPR.....the above amount upon receipt of its first written demand without the SJVN Arun-3 Power Development Company Private Limited having to substantiate its demand, provided that in its demand the SJVN Arun-3 Power Development Company Private Limited will note that the amount claimed by it due to it owing to the occurrence of one or any of the two conditions, specifying the occurred condition or conditions.

This Guarantee will remain in force up to and including the date 210 days after the deadline for submission of Bids as stated in the invitation to bid or as it may be extended by the SJVN Arun-3 Power Development Company Private Limited notice of which extensions(s) to the Bank is hereby waived. Any demand in respect of this Guarantee should reach the Bank not later than the above date.

DATE _____

SIGNATURE OF THE BANK _____

WITNESS _____

SEAL _____

(Signature, name and address)

2. FORM OF BANK GUARANTEE FOR PERFORMANCE SECURITY DEPOSIT

(Refer clause 29.0 of ITB)

Date:

To,

Name & Address of the Employer

We have been informed that(the "company"), having its registered office at has entered into a Agreement on20.... with you for the work of "Improvement of Katwaldada to Lumbang Road (RD 0.00 to 1.479 km), Makalu RM-05, Num, Distt. Sankhuwasabha, Nepal under Local Benefit Sharing Plan (LBSP) of Arun-3 Hydro Electric Project (900 MW)."

In accordance with the terms of the AGREEMENT, the Company is required to submit an unconditional and irrevocable, payable on-demand bank guarantee of NPR (Nepalese Rupees only), (the "**Security Amount**") to SAPDC for the due and faithful performance of the Company's obligations under the AGREEMENT (the "**Performance Security**") and we(name and address of the Bank, hereinafter called the "**Guarantor**") have at the request of the Company agreed to provide such Performance Security, being this Bank Guarantee (Performance Security) No.

On your first written demand, stating that (a) the Company is in default of its obligations under the AGREEMENT, or (b) the Company has not replaced this Performance Security with another performance security issued on the same terms at least fourteen (14) days prior to the Expiry Date (as hereinafter defined), we, the Guarantor as primary obligor hereby expressly, unconditionally and irrevocably undertake to pay to SAPDC, without demur, reservation, protest and any reference to the Company or the AGREEMENT the amount specified in such demand, provided that the total of all demands shall not exceed the sum of the Security Amount. You shall not be required to prove or show grounds for your demand or the sum specified therein. It is clarified further that your demand shall be conclusive evidence to us that such payment is due under the terms of the AGREEMENT. It shall not be necessary, and the Guarantor hereby waives any necessity, for SAPDC to proceed against the Company before presenting to the Guarantor its demand under the Performance Security.

The term of this Performance Security shall commence on the date of its issuance and shall expire on the date 45 days beyond the defect liability Period (the "**Expiry Date**").

All claims, if any, in respect of this Performance Security must be received by the Guarantor on or before the Expiry Date.

This guarantee is subject to Uniform Rules for Demand Guarantees ICC Publication No. 758, except that the provisions of Article 26 are hereby excluded and shall be governed by and construed in accordance with the Laws of Nepal and will be subject to the jurisdiction of the courts of Nepal.

The Performance Security shall not be affected by any change in the constitution of the Guarantor or of the Company.

Notwithstanding anything contained hereinabove:

- (1) Our liability under this Guarantee shall not exceed the Security Amount

- (2) Any demand may be brought by SAPDC under this Guarantee up to close of business on the Expiry Date.
- (3) We shall be liable to pay any amount under this Guarantee or part thereof only if we receive a claim or demand in writing within banking hours at our branch on or before the Expiry Date and if no such demand has been received by us by that time and date, all rights to bring any demand under this guarantee will cease.

Notwithstanding sub-section (2) and (3) above, all claims made by SAPDC on or before the Expiry Date shall, subject to sub-section (1) above, be honoured by the Guarantor where payment in respect of such demands have not been made by the Expiry Date.

This guarantee (or any of its proceeds) is not assignable and is not transferable in whole or in part.

Upon payment by the Guarantor in respect of all claims or demands made by SAPDC under this Bank Guarantee on or before the Expiry Date, this guarantee automatically becomes null and void whether or not the original has been returned to us.

Signed for and on behalf of:

Name:

Designation:.....

Seal of the Bank:.....

Signed for and on behalf of:

[Note: delete the following signature block if not applicable]

[Signed for and on behalf of confirming bank in Nepal:.....

Name:.....

Designation:.....

Seal of the Bank:.....

Signed for and on behalf of:...../

3. PROFORMA FOR AGREEMENT

This agreement made this _____ day of _____ between _____ (name and address of Employer) (hereinafter called “SJVN Arun-3 Power Development Company Private Limited/SAPDC/Employer”) and _____ (name and address of Contractor) (hereinafter called “the Contractor” of the other party).

Whereas the SJVN Arun-3 power Development Company Private Limited is desirous that the Contractor executes _____ (name and identification number of Contract) (hereinafter called ‘the Works’) and the SJVN Arun-3 Power Development Company Private Limited has accepted the Bid by the Contractor for the execution and completion of such Works and the remedying of any defects herein at a contract price of NPR _____

NOW THIS AGREEMENT WITNESSETH as follow:

1. In this Agreement, words and expression shall assume the same meanings as are respectively assigned to them in the Conditions of Contract hereinafter referred to.
2. In consideration of the payments to be made by the SJVN Arun-3 Power Development Company Private Limited to the Contractor as hereinafter mentioned, the Contractor hereby covenants with the SJVN Arun-3 Power Development Company Private Limited to execute and complete the Work and remedy the defects therein in conformity, in all aspects, with the provisions of the Contract.
3. The SJVN Arun-3 Power Development Company Private Limited hereby covenants to pay the Contractor in consideration of the execution and completion of the Works and remedy the defects wherein the contract price or such other sum as may become payable under the provisions of the Contract at the times and in the manner prescribed by the Contract.
4. The following documents shall be deemed to form and be read and construed as part of this Agreement, viz:
 - a) This Contract Agreement
 - b) Letter of acceptance issued by Employer;
 - c) Special Conditions of Contract;
 - d) General Conditions of Contract;
 - e) Detailed Scope of Work and Technical Specifications;
 - f) Priced Bill of Quantities;
 - g) Contractor’s Bid other than BOQ;
 - h) Tender Drawings;
 - i) Instructions to Bidders

j) Any other document forming part of the Contract

The aforesaid documents shall be taken as complementary and mutually explanatory of one another but in case of ambiguities or discrepancies shall take precedence in the order set out above.

In witness whereof the parties have caused this Agreement to be executed the day and year first before written.

Signed and Delivered

For and on behalf of the Contractor

For and on behalf of SJVN Arun-3 power
Development Company Private Limited

i) Name: _____

Name: _____

(Authorized Signatory)

ii) Name : _____

Designation:

In the presence of:

In the presence of :

Name _____

Name _____

Add. _____

Add. _____

Note: This Performa is included in the Bidding Documents only for the information of the Bidders. Only the successful bidder, shall, in due course, be required to fill this Performa.

SECTION –VI

SPECIAL CONDITIONS OF THE CONTRACT (SCC)

SPECIAL CONDITIONS OF CONTRACT (SCC)

- 1) The contractor shall make his own arrangement for electricity & water supply, required for the execution of work, at his own cost.
- 2) No material and T&P will be issued by SAPDC.
- 3) Successful Bidder shall comply with all relevant quality, safety standards and all rules/ laws of Govt. of Nepal.
- 4) The work is to be done in smooth manner without hindrances to the works of other agencies, local people, surroundings and environments and as per the instructions of the Engineer-in-Charge.
- 5) Taxes will be deducted as per rules applicable at the time of execution of work.
- 6) Labour rules & conditions as circulated by the Central Govt./State Govt. from time to time shall be strictly observed by the Contractor and will abide the same.
- 7) **Clause 40 of GCC, Milestones:**

S. No.	Mile stone	Schedule completion period reckoned from the 15th day of issuance of LOA.	Compensation for delay
1.	Completion of work as whole	6 (six) months	0.1% of Contract Price per day of delay in completion of work shall be levied subject to maximum of 5% of the Contract Price

SECTION-VII

TENDER DRAWINGS



SJVN Arun-3 Power Development Company Pvt. Ltd. (SAPDC)

Tumlingtar, Nepal

DETAILED PROJECT REPORT (VOLUME-II)

Drawing on

Detailed Engineering Survey, Design and Cost Estimate of Katwaldada to Lumbang Road

Chainage: 0+000-1+479



Consultant:

Dhor Barahi Engineering Services Pvt. Ltd.

Sankhamul, Kathmandu

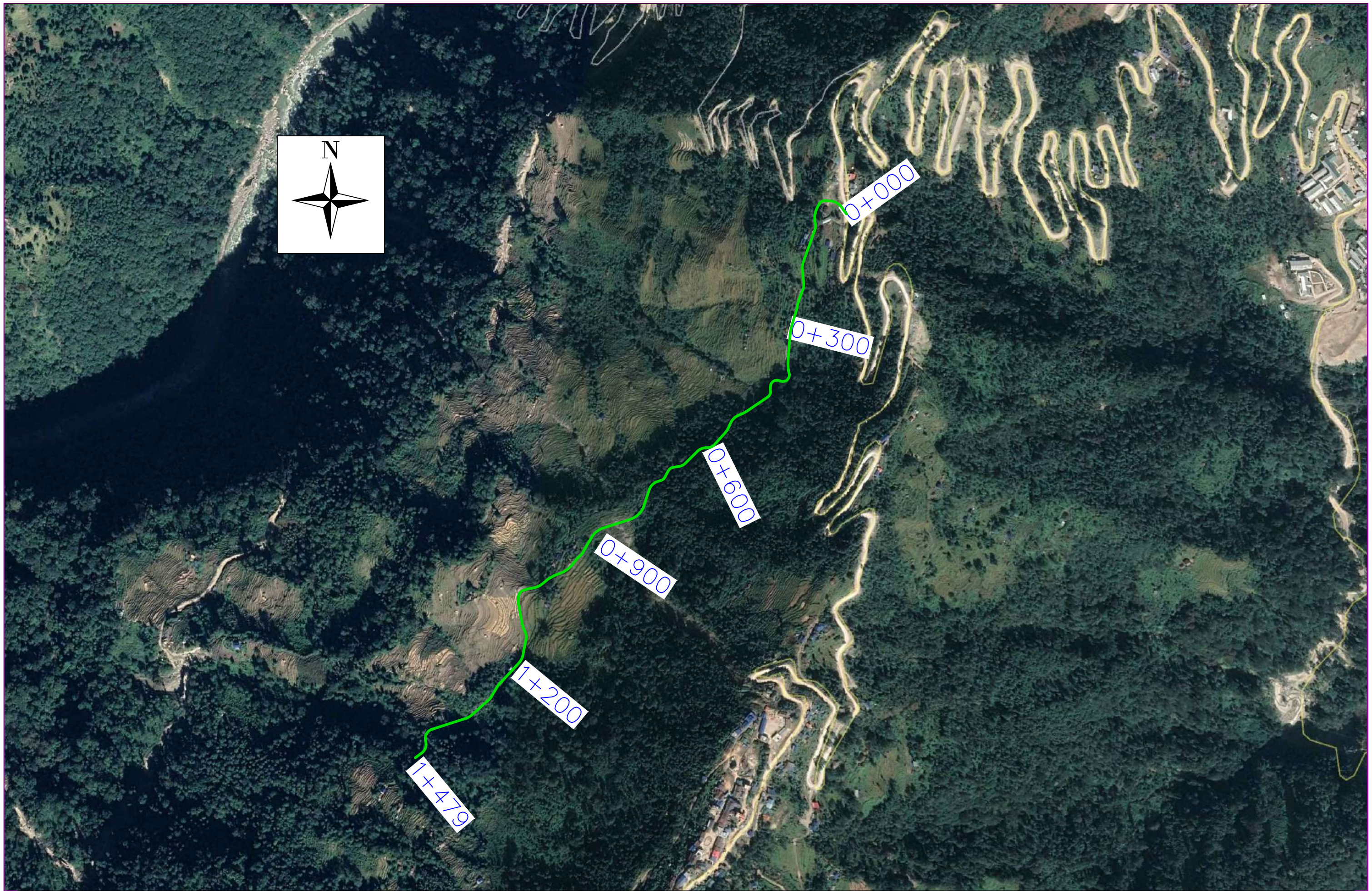
SATELLITE MAP



DEVELOPER		SJVN Arun-3 Power Development Company Pvt. Ltd. (SAPDC) Tumlingtar, Nepal	PROJECT	Katwaldada to Lumbang Road			SCALE		
				Designed By	Murli Shah				
CONSULTANT		Dhor Barahi Engineering Services Pvt. Ltd Sankhamul, Kathmandu	TITLE	Satellite Map			DRAWING NO.		
				Drawn By					
				Checked By					
				Approved By					

TYPICAL SECTION

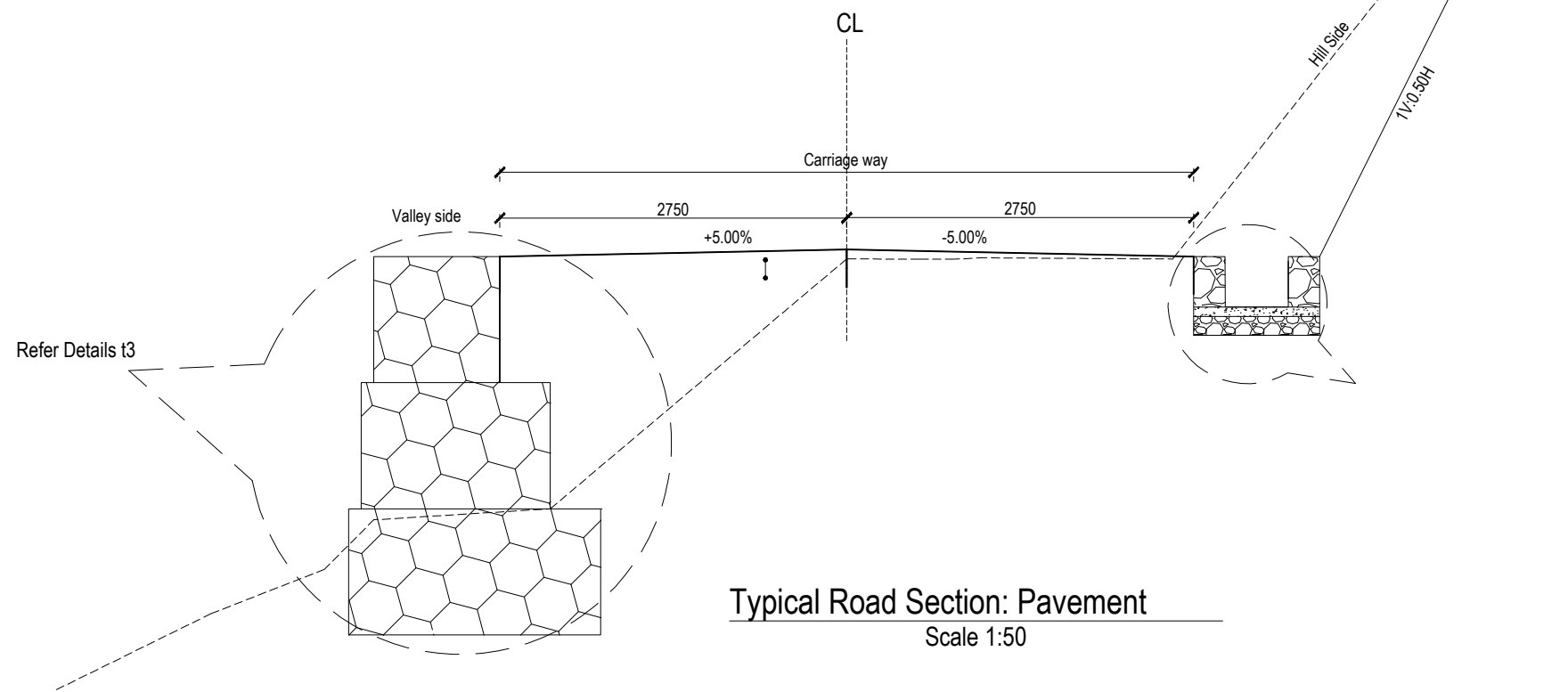

Typical Road Section: Pavement
Scale 1:50

Backfill Level

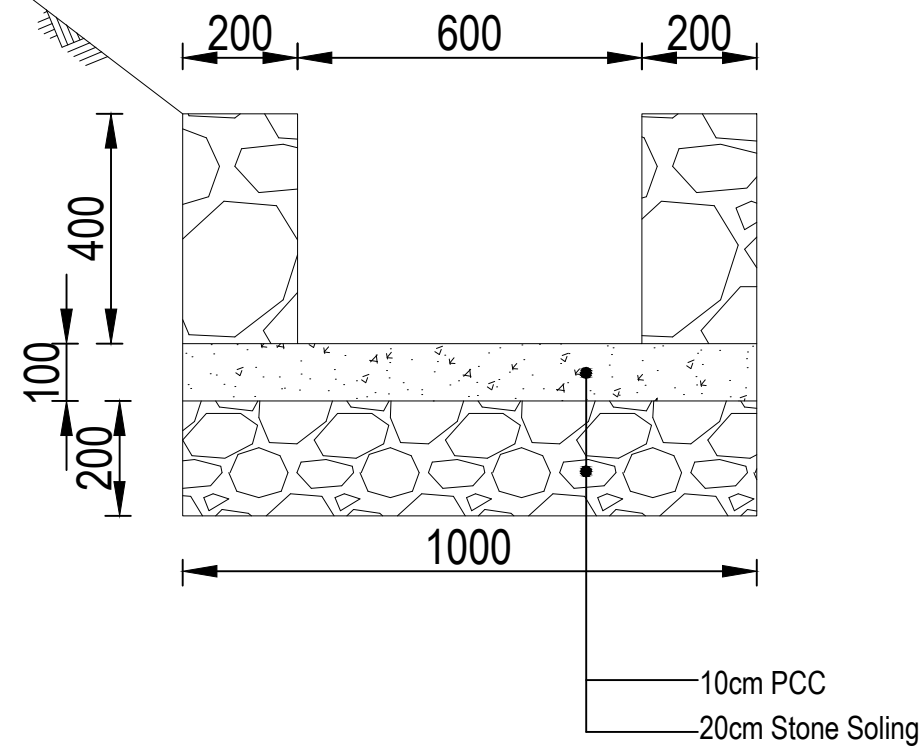

All dimensions are in mm

DEVELOPER		SJVN Arun-3 Power Development Company P. L. (SAPDC) Tumlingtar, Nepal		PROJECT	Katwaldada to Lumbang Road		Designed By	Murli Shah	SCALE	Given Above	TITLE: TYPICAL SECTIONS
		CONSULTANT			Dhor Barahi Engineering Services Pvt. Ltd Sankhamul, Kathmandu		Checked By				

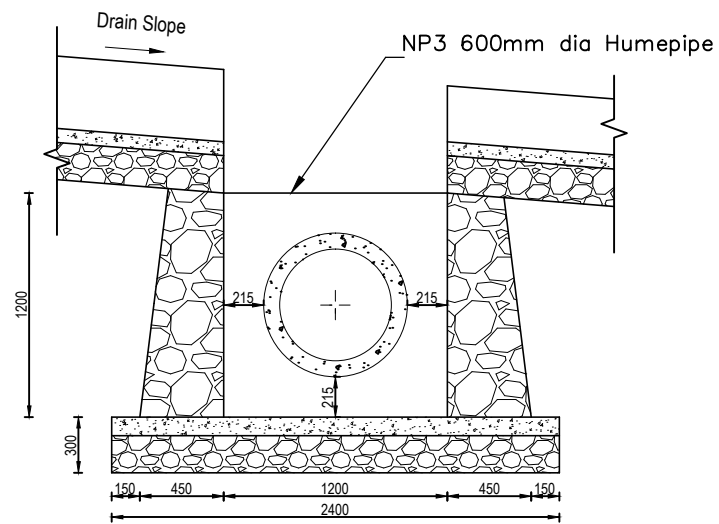

Typical section of Catchpit for 600mm HP
Scale 1:40

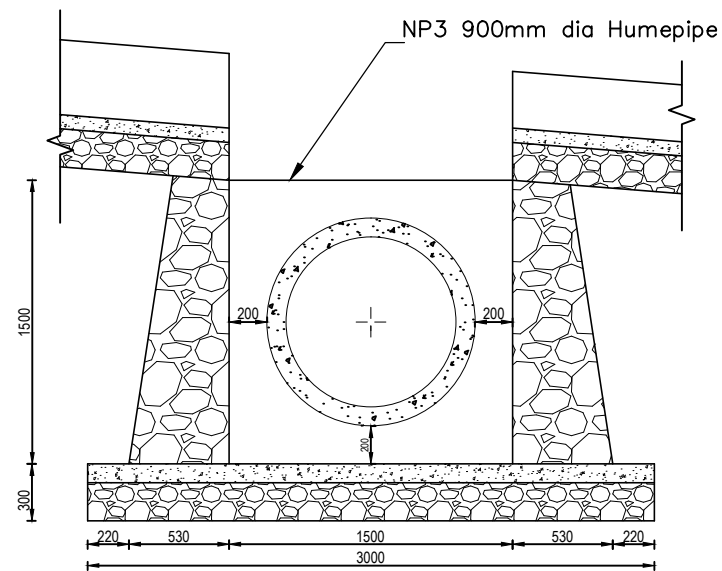

Typical section of Catchpit for 900mm HP
Scale 1:40

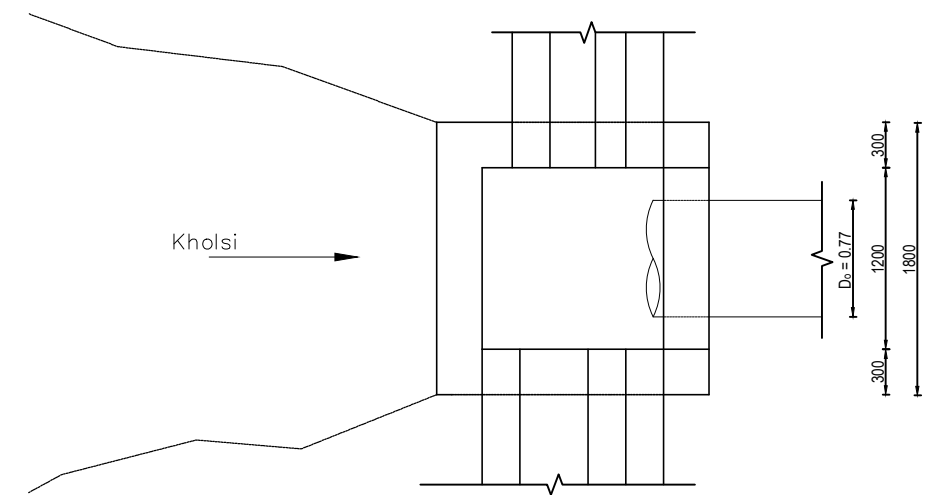

Plan of Catchpit for 600mm HP
Scale 1:50

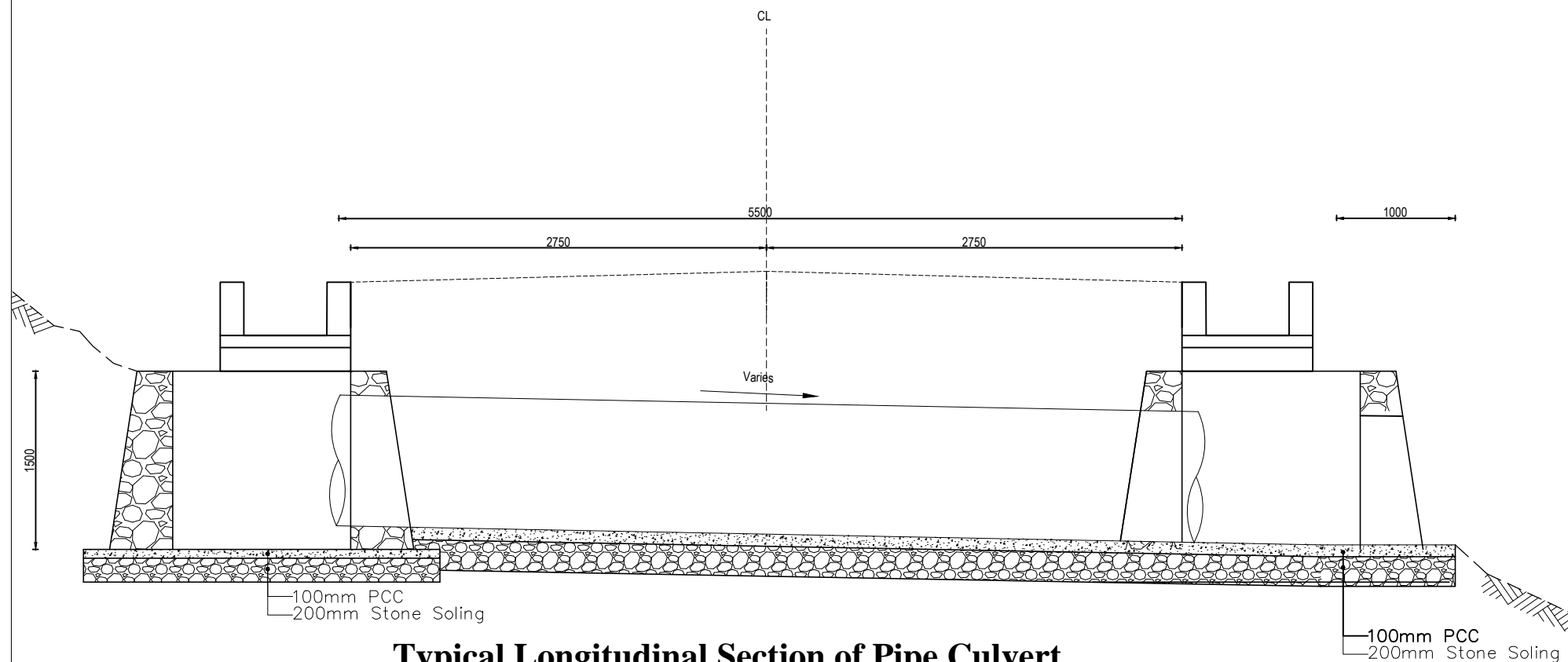

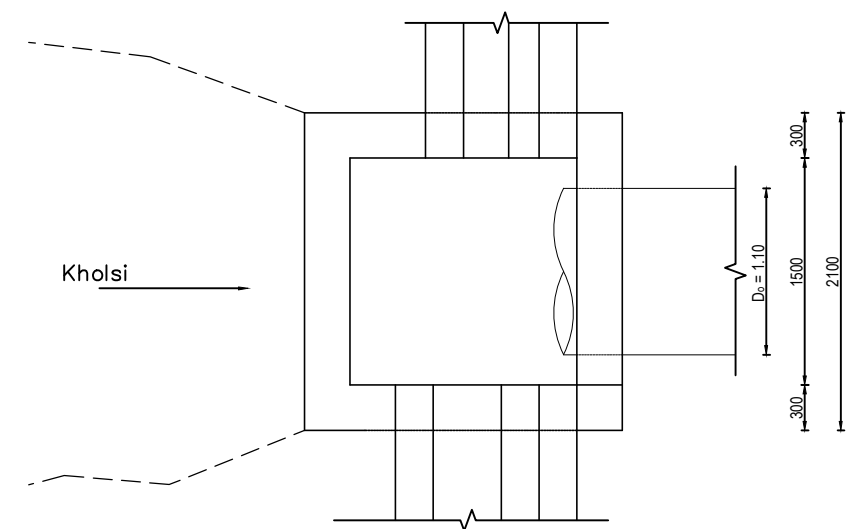

Typical Longitudinal Section of Pipe Culvert
Scale 1:50



Plan of Catchpit for 900mm HP
Scale 1:50

All dimensions are in mm

DEVELOPER	 SJVN Arun-3 Power Development Company P. L. (SAPDC) Tumlingtar, Nepal	PROJECT	Katwaldada to Lumbang Road	Designed By	Murli Shah	SCALE	Given Above	TITLE: TYPICAL SECTIONS
				Signature				
CONSULTANT	 Dhor Barahi Engineering Services Pvt. Ltd Sankhamul, Kathmandu			Checked By		DRAWING NO.		
				Approved By				

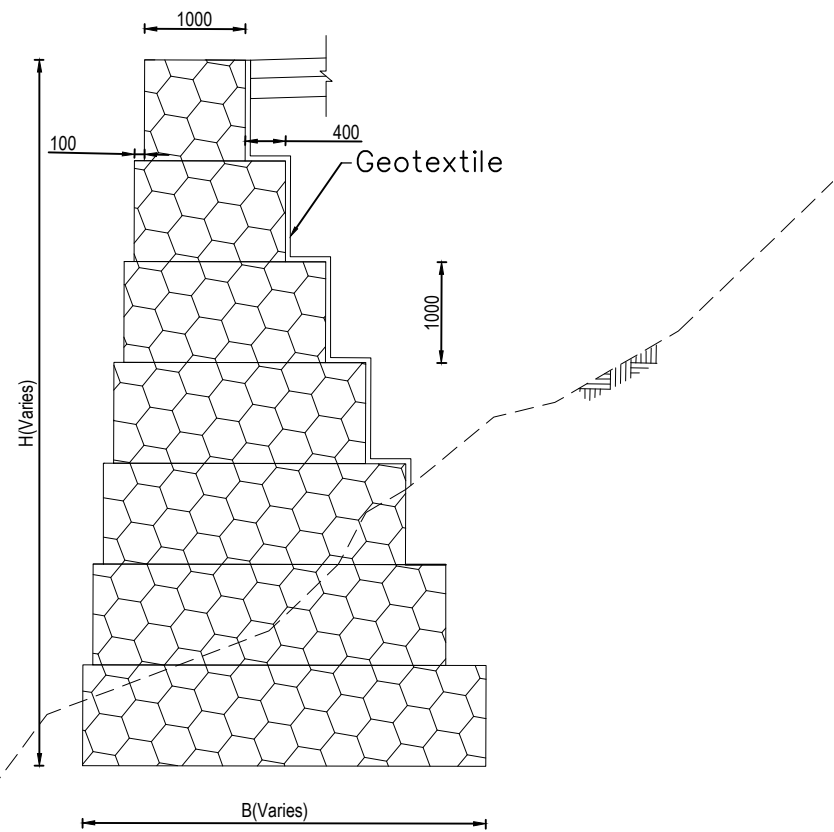

Scale 1:75

Typical Section of Gabion Wall

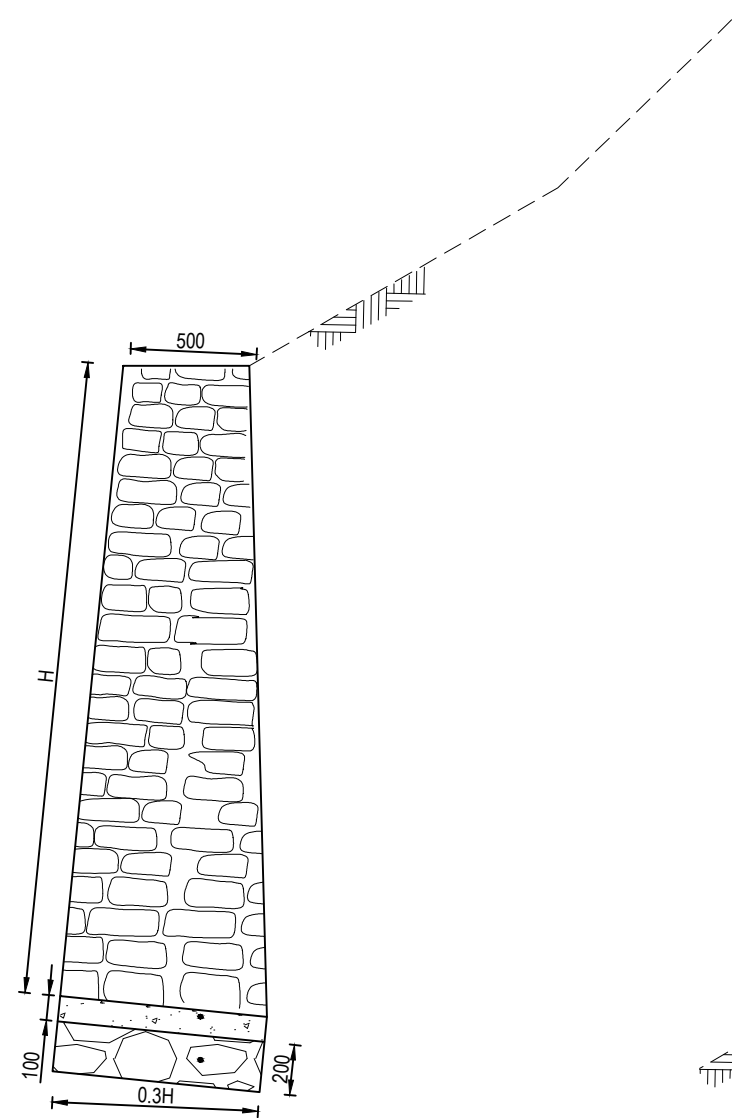

Typical Section of Masonry Breast wall
Scale 1:30

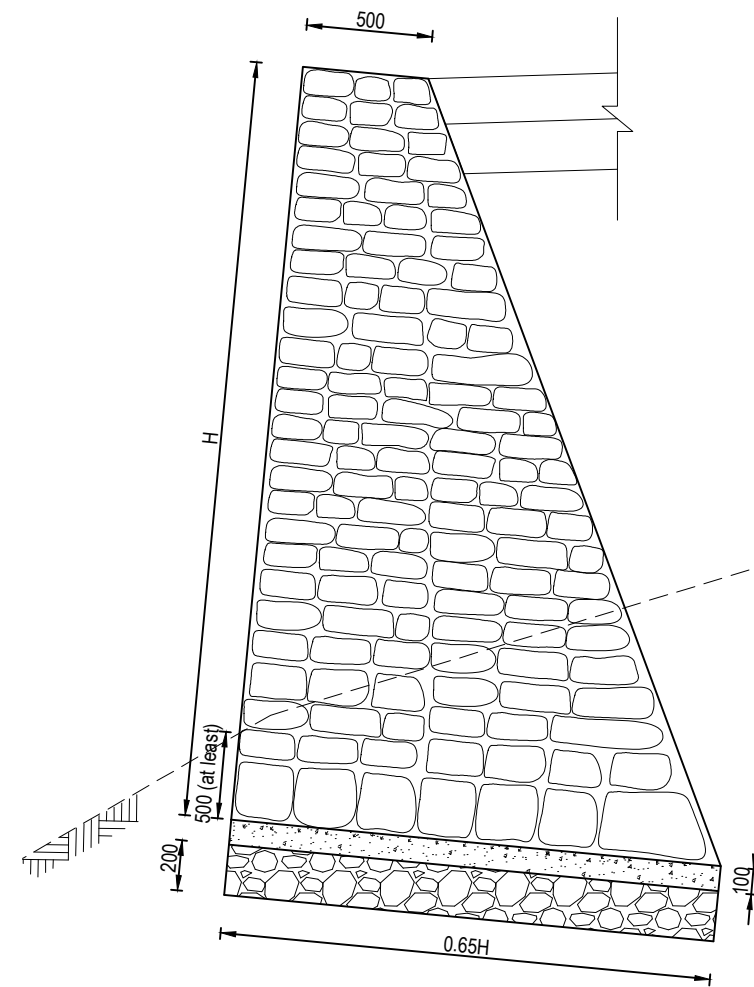

Typical Section of Masonry Retaining Wall
Scale 1:30

All dimensions are in mm

DEVELOPER		SJVN Arun-3 Power Development Company P. L. (SAPDC) Tumlingtar, Nepal		PROJECT	Katwaldada to Lumbang Road		Designed By	Murli Shah	SCALE	Given Above		TITLE: TYPICAL SECTIONS
		CONSULTANT			Dhor Barahi Engineering Services Pvt. Ltd. Sankhamul, Kathmandu		Checked By			DRAWING NO.		
								Approved By				

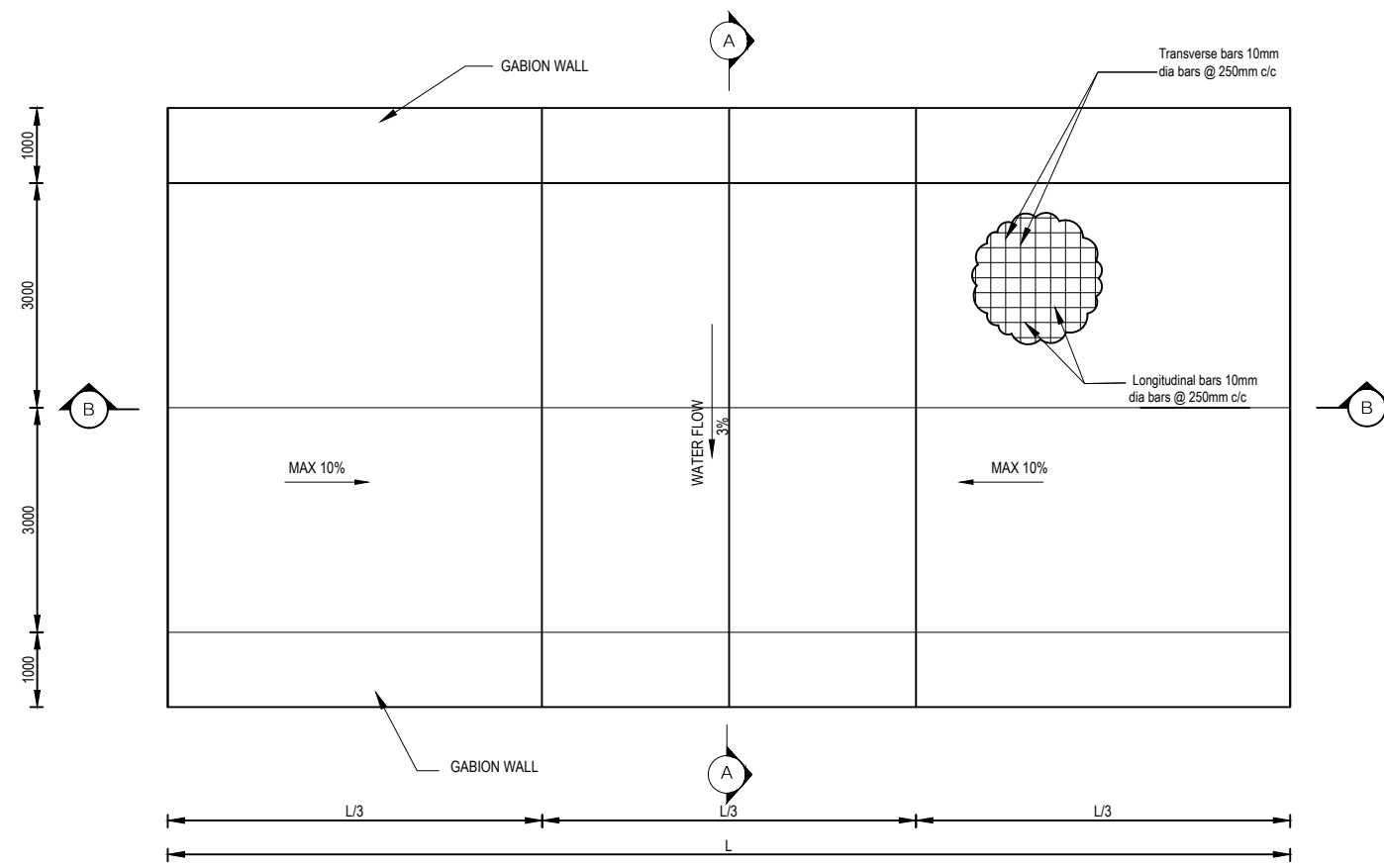

Causeway Plan
Scale 1:75

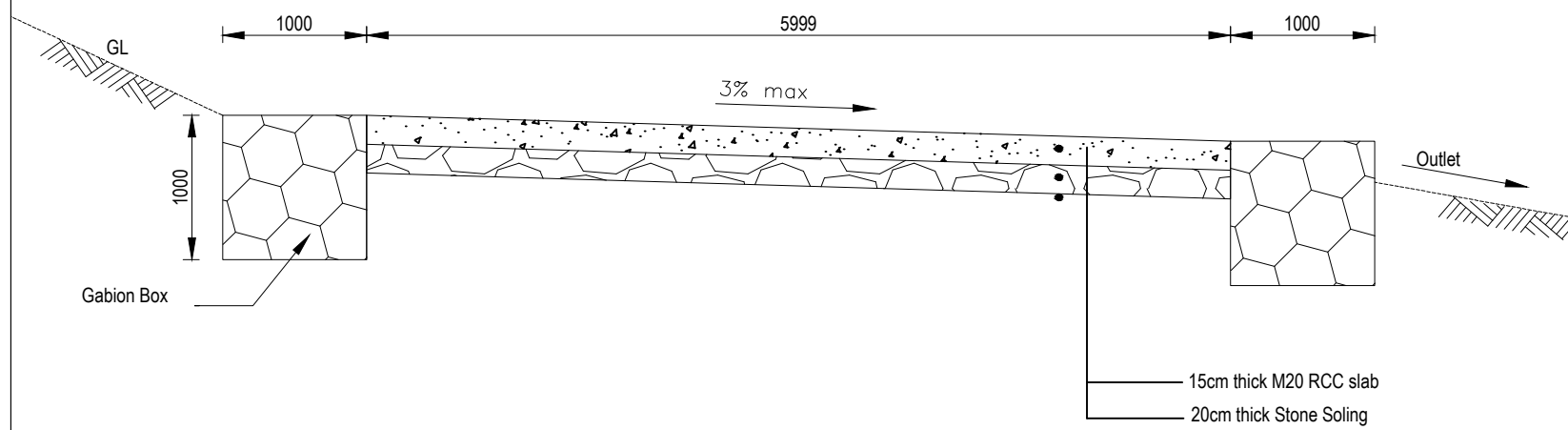

Section at A-A
Scale 1:50

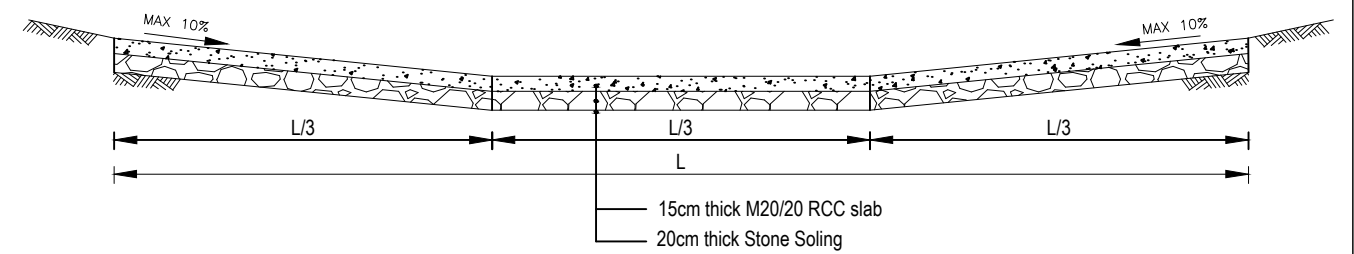

Section at B-B
Scale 1:100

All dimensions are in mm

DEVELOPER		SJVN Arun-3 Power Development Company Pvt. Ltd. (SAPDC) Tumlingtar, Nepal		PROJECT	Katwaldada to Lumbang Road	Designed By	Murli Shah	SCALE	Given Above	TITLE: TYPICAL SECTIONS
		Signature								
CONSULTANT		Dhor Barahi Engineering Services Pvt. Ltd. Sankhamul, Kathmandu				Checked By		DRAWING NO.		
		Approved By								

INTEGRITY PACT-PRE-CONTRACT

Between

SJVN Arun-3 Power Development Company (P) Ltd. (SAPDC), a company incorporated under the Companies Act 2063 and having its registered office at Lokanthali, Kathmandu, Nepal, hereinafter referred to as "The Employer" which expression shall mean and include, unless the context otherwise requires, his successors in office and assigns of the **First Part**.

And

M/s _____, a company/ firm/ individual (status of the company) constituted in accordance with the relevant law in the matter and having its registered office at _____ represented by Shri/Smt. _____, Authorized Person, hereinafter referred to as "The Bidder/Contractor" which expression shall mean and include, unless the context otherwise requires, his successors and permitted assigns of the **Second Part**.

WHEREAS the Employer proposes to procure ~~under~~ laid down organizational procedures, _____ contract _____ for "Improvement of Kat Walada to Lumbang Road (RD 0:00 to 1.479 km), Manalu RM-05, Nurn, Distt. Sankhuwasabha, Nepal Under Local Benefit Sharing Plan (LBSP) of Arun Hydro Electric Project (G.E.M.H.)" and the Bidder/Contractor is willing to offer against Tender No. SAPDC/P&C/PCD-212/2022-24 dated 07-01-2022

NOW, THEREFORE,

To avoid all forms of corruption by following a system that is fair, transparent and free from any influence/prejudiced dealings prior to, during and subsequent to the currency of the contract to be entered into with a view to:-

Enabling the Employer to obtain the desired said (work/ goods/ services) at a competitive price in conformity with the defined specifications by avoiding the high cost and the distortionary impact of corruption on public procurement, and

Enabling the Bidder(s)/Contractor(s) to abstain from bribing or indulging in any corrupt practice in order to secure the contract by providing assurance to them that their competitors will also abstain from bribing and other corrupt practices and the Employer will commit to prevent corruption, in any form, by its officials by following transparent procedures.



1.0 Commitments of the Employer

- 1.1 The Employer undertakes that no official of the Employer, connected directly or indirectly with the contract, will demand, take a promise for or accept, directly or through intermediaries, any bribe, consideration, gift, reward, favour or any material or immaterial benefit or any other advantage from the Bidder/Contractor, either for themselves or for any person, organization or third party related to the contract in exchange for an advantage in the bidding process, bid evaluation, contracting or implementation process related to the contract.
- 1.2 The Employer will, during the pre-contract stage, treat all the Bidders/Contractors alike, and will provide to all the Bidders/Contractors the same information and will not provide any such information to any particular Bidder/Contractor which could afford an advantage to that particular Bidder/Contractor in comparison to other Bidders/Contractors.
- 1.3 All the officials of the Employer will report to the appropriate Authority any attempted or completed breaches of the above commitments as well as any substantial suspicion of such a breach.
- 1.4 In case any such preceding misconduct on the part of such official(s) is reported by the Bidder to the Employer with full and verifiable facts and the same is prima facie found to be correct by the Employer, necessary disciplinary proceedings, or any other action as deemed fit, including criminal proceedings may be initiated by the Employer or Independent External Monitor and such a person shall be debarred from further dealings related to the contract process. In such a case while an enquiry is being conducted by the Employer the proceedings under the contract would not be stalled.

2.0 Commitments of the Bidder(s)/Contractor(s)

The Bidder(s)/Contractor(s) commits itself to take all measures necessary to prevent corrupt practices, unfair means and illegal activities during any stage of its bid or during any pre-contract or post-contract stage in order to secure the contract or in furtherance to secure it and in particular commit itself to the following :-

- 2.1 The Bidder(s)/Contractor(s) will not offer, directly or through intermediaries, any bribe, gift, consideration, reward, favour, any material or immaterial benefit or other advantage, commission, fees, brokerage or inducement to any official of the Employer, connected directly or indirectly with the bidding process, or to any person, organization or third party related to the contract in exchange for any advantage in the bidding, evaluation, contracting and implementation of the contract.



- 2.2 The Bidder/Contractor further undertakes that it has not given, offered or promised to give, directly or indirectly any bribe, gift consideration, reward, favour, any material or immaterial benefit or other advantage, commission, fees, brokerage or inducement to any official of the Employer or otherwise in procuring the Contract or forbearing to do or having done any act in relation to the obtaining or execution of the contract or any other contract with Employer for showing or forbearing to show favour or disfavour to any person in relation to the contract or any other contract with Employer.
- 2.3 The Bidder(s)/Contractor(s) shall disclose the name and address of agents and representatives and Indian Bidder(s)/Contractor(s) shall disclose their foreign principals or associates.
- 2.4 The Bidder(s)/Contractor(s) shall disclose the payments to be made by them to agents/brokers or any other intermediary, in connection with this bid/contract
- 2.5 The Bidder, either while presenting the bid or during pre-contract negotiations or before signing the contract, shall disclose any payments he has made, is committed to or intends to make to officials of the Employer or their family members, agents, brokers or any other intermediaries in connection with the contract and the details of services agreed upon for such payments.
- 2.6 The Bidder/Contractor will not collude with other parties interested in the contract to impair the transparency, fairness and progress of the bidding process, bid evaluation, contracting and implementation of the contract.
- 2.7 The Bidder/Contractor will not accept any advantage in exchange for any corrupt practice, unfair means and illegal activities.
- 2.8 The Bidder/Contractor shall not use improperly, for purposes of competition or personal gain, or pass on to others, any information provided by the Employer as part of the business relationship, regarding plans, technical proposals and business details, including information contained in electronic data carrier. The Bidder/Contractor also undertakes to exercise due and adequate care lest any such information is divulged.
- 2.9 The Bidder(s)/Contractor(s) commits to refrain from giving any complaint directly or through any other manner without supporting it with full and verifiable facts.
- 2.10 The Bidder(s)/Contractor(s) shall not instigate or cause to instigate any third person to commit any of the actions mentioned above.
- 2.11 If the Bidder/Contractor or any employee of the Bidder/Contractor or any person acting on behalf of the Bidder/Contractor, either directly or indirectly, is a relative of any of the officers of the Employer, or alternatively, if any relative of an officer of the Employer has financial interest/stake in the Bidder(s)/Contractor(s) firm (excluding



Public Ltd. Company listed on Stock Exchange), the same shall be disclosed by the Bidder/Contractor at the time of filling of tender.

The term 'relative' for this purpose would be as defined in Section 2(77) of the Companies Act, 2013 (India).

- 2.12 The Bidder(s)/Contractor(s) shall not lend to or borrow any money from or enter into any monetary dealings or transactions, directly or indirectly, with any employee of the Employer.
- 2.13 The Bidder/supplier shall follow all rules and regulations of India and/or Nepal including statutory requirements like minimum wages, ESIC and EPF/Social Security Fund.

3.0 Previous Transgression

- 3.1 The Bidder(s)/Contractor(s) declares that no previous transgression occurred in the last three years immediately before signing of this Integrity Pact, with any other company in any country in respect on any corrupt practices envisaged hereunder or with any Public Sector Enterprise / Government Department in India and in Nepal (*Employer's country*).
- 3.2 The Bidder agrees that if it makes incorrect statement on this subject, Bidder can be disqualified from the tender process or the contract, if already awarded, can be terminated for such reason.

4.0 Earnest Money (Security Deposit)

The provision regarding Earnest Money/Security Deposit as detailed in the Notice Inviting Tender (NIT) and Instruction to Bidders (ITB) section of the Bid Document is to be referred.

5.0 Sanctions for Violations

- 5.1 Any breach of the aforesaid provisions by the Bidder/Contractor or any one employed by it or acting on its behalf shall entitle the Employer to take action as per the procedure mentioned in the "**Guidelines on Banning of Business Dealings**" attached as **Annex-A** and initiate all or any one of the following actions, wherever required:
- (i) To immediately disqualify the bidder and call off the pre contract proceedings without assigning any reason or giving any compensation to the Bidder/Contractor. However, the proceedings with the other Bidder(s)/Contractor(s) would continue.



- (ii) The Earnest Money Deposit (in pre-contract stage) and/or Security Deposit/Performance Bond (after the contract is Signed) shall stand forfeited either fully or partially, as decided by the Employer and the Employer shall not be required to assign any reason thereof.
- (iii) To immediately cancel the contract, if already signed, without giving any compensation to the Contractor. The Bidder/Contractor shall be liable to pay compensation for any loss or damage to the Employer resulting from such cancellation/rescission and the Employer shall be entitled to deduct the amount so payable from the money(s) due to the Bidder/Contractor.
- (iv) To encash the Bank guarantee, in order to recover the dues if any by the Employer, along with interest as per the provision of contract.
- (v) To debar the Bidder/Contractor from participating in future bidding processes of Employer, as per provisions of "Guidelines on Banning of Business Dealings" (**Annex-A**), which may be further extended at the discretion of the Employer.
- (vi) To recover all sums paid in violation of this Pact by Bidder(s)/Contractor(s) to any middleman or agent or broker with a view to securing the contract.
- (vii) In cases where irrevocable Letters of Credit have been received in respect of any contract signed by the Employer with the Bidder/ Contractor, the same shall not be opened/operated.
- (viii) Forfeiture of Performance Security in case of a decision by the Employer to forfeit the same without assigning any reason for imposing sanction for violation of this Pact.

5.2 The Employer will be entitled to take all or any of the actions mentioned at para 5.1 (i) to (viii) of this Pact also on the Commission by the Bidder/Contractor or any one employed by it or acting on its behalf (whether with or without the knowledge of the Bidder/Contractor), of an offence as defined in GFR, Chapter IX of the Indian Penal Code, 1860 or Prevention of Corruption Act, 1988 or any other statute enacted for prevention of corruption in Employer's country.

5.3 The decision of the Employer to the effect that a breach of the provisions of this Pact has been committed by the Bidder/Contractor shall be final and conclusive on the Bidder/Contractor. However, the Bidder/Contractor can approach the Independent External Monitor(s) appointed for the purposes of this Pact.

6.0 Independent External Monitor(s)

6.1 The Employer has appointed Independent External Monitor(s) (hereinafter referred to as Monitors) for this Pact.

6.2 The task of the Monitors shall be to review independently and objectively, whether and to what extent the parties comply with the obligations under this Pact.



- 6.3 The Monitors shall not be subject to instructions by the representatives of the parties and perform their functions neutrally and independently.
- 6.4 Both the parties accept that the Monitors have the right to access all the documents relating to the project/procurement for which a complaint or issue is raised before them, including minutes of meetings. The right to access records should only be limited to the extent absolutely necessary to investigate the issue related to the subject tender/contract.
- 6.5 As soon as the Monitor notices, or has reason to believe, a violation of this Pact, he will so inform CMD/CEO/MD of Employer and request Employer to discontinue or take corrective action, or to take other relevant action. The Monitor can in this regard submit non-binding recommendations. Beyond this the Monitor has no right to demand from the parties that they act in a specific manner, refrain from action or tolerate action.
- 6.6 The Bidder(s)/Contractor(s) accepts that the Monitor has the right to access without restriction, to all Project documentation of the Employer including that provided by the Bidder/Contractor. The Bidder/Contractor will also grant the Monitor, upon his request and demonstration of a valid interest, unrestricted and unconditional access to his project documentation. The same is applicable to Subcontractor(s). The Monitor shall be under contractual obligation to treat the information and documents of the Bidder/Contractor/Subcontractor(s) with confidentiality.
- 6.7 The Employer will provide to the Monitor sufficient information about all meetings among the parties related to the project provided such meetings could have an impact on the contractual relations between the parties. The parties will offer to the Monitor the option to participate in such meetings as and when required.
- 6.8 The Monitor will submit a written report to the CMD/CEO/MD of Employer within 30 days from the date of reference or intimation to him by the Employer/Bidder and should the occasion arise, submit proposals for correcting problematic situations.
- 6.9 The word 'Monitor' would include both singular and plural.
- 6.10 In the event of a dispute between the management and the contractor related to those contracts where integrity pact is applicable, in case both the parties agree, they may try to settle the dispute through mediation before the panel of IEMs in a time bound manner. In case the dispute remains unresolved even after mediation by the panel of IEMs, SJVN may take further action as per the terms and conditions of Contract. Expenses on dispute resolution shall be equally shared by both the parties.



7.0 Facilitation of Investigation

In case of any allegation of violation of any provisions of this Pact or payment of commission, the Employer or its agencies shall be entitled to examine all the documents including the Books of Accounts of the Bidder/Contractor and the Bidder/Contractor shall provide necessary information and documents, in English and shall extend all possible help for the purpose of such examination.

8.0 Law and Place of Jurisdiction

This Pact is subject to Nepal's Law. The place of performance and jurisdiction is the Registered Office of the Employer. The arbitration clause provided in the tender document/contract shall not be applicable for any issue/dispute arising under Integrity Pact.

9.0 Other Legal Actions

9.1 The actions stipulated in this Integrity Pact are without prejudice to any other legal action that may follow in accordance with the provisions of the extant law in force relating to any civil or criminal proceedings.

9.2 Changes and supplements as well as termination notice need to be made in writing.

9.3 If the Contractor is a partnership or a consortium or a joint venture, this pact must be signed by all partners of the consortium/joint venture.

10.0 Validity

10.1 The validity of this Integrity Pact shall be from date of its signing and extend upto 5 years or the complete execution of the contract to the satisfaction of both the Employer and the Bidder/Contractor/Seller, including warranty period, whichever is later. In case BIDDER is unsuccessful, this Integrity Pact shall expire after six months from the date of the signing of the contract or six months from the date of opening of price bids, whichever is earlier.

10.2 Should one or several provisions of this Pact turn out to be invalid, the remainder of this Pact shall remain valid. In this case, the parties will strive to come to an agreement to their original intention.

11.0 The Parties hereby sign this Integrity Pact at _____ on _____.



Employer



Name of the Officer: **Vivek Sharma**

Designation: **CE (P&C)**

Place-----

Date-----

Witness1. _____

(Name and address)

2. _____

(Name and address)

Bidder

(Authorised Person)

(Name of the Person)

Designation

Place-----

Date-----

Witness1. _____

(Name and address)

2. _____

(Name and address)

GUIDELINES ON BANNING OF BUSINESS DEALINGS

1.0 Introduction

- 1.1 Employer deals with Agencies viz. parties/ contractors/ suppliers/ bidders, who are expected to adopt ethics of highest standards and a very high degree of integrity, commitments and sincerity towards the work undertaken. It is not in the interest of Employer to deal with Agencies who commit deception, fraud or other misconduct in the tendering process.
- 1.2 Since banning of business dealings involves civil consequences for an Agency concerned, it is incumbent that adequate opportunity of hearing is provided and the explanation, if tendered, is considered before passing any order in this regard keeping in view the facts and circumstances of the case.

2.0 Scope

- 2.1 The Information for Bidders/ Instruction to Bidders/Notice Inviting Tender/Notice Inviting Quotations and even the General Conditions of Contract (GCC) of Employer generally provide that Employer shall have the rights to remove from list of approved suppliers / contractors or to ban business dealings if any Agency has been found to have committed misconduct or fraud or anything unethical not expected from a reputed contractor.
- 2.2 The procedure of (i) Removal of Agency from the List of approved suppliers / contractors; (ii) Suspension and (iii) Banning of Business Dealing with Agencies, has been laid down in these guidelines.
- 2.3 These guidelines shall apply to all the Projects/ Power Stations/ Regional Offices/ Liaison Offices of SJVN including its subsidiaries and JVs.
- 2.4 It is clarified that these guidelines do not deal with the poor performance of the contractors/ Agencies.
- 2.5 The banning shall be with prospective effect, i.e. future business dealings.

3.0 Definitions

In these Guidelines, unless the context otherwise requires:

- i) **"Party / Contractor / Supplier / Bidders"** shall mean and include a public limited company or a private limited company, a joint Venture, Consortium, HUF, a firm whether registered or not, an individual, cooperative society or an association or a group of persons engaged in any commerce, trade, industry, etc. "Party / Contractor/ Supplier / Bidder" in the context of these guidelines is indicated as 'Agency'.



- ii) **“Unit”** shall mean the Project/ Power Station/ Regional Office/ Liaison Office.
- iii) **“Competent Authority”** and **‘Appellate Authority’** shall mean the following:

The concerned Director shall be the ‘Competent Authority’ for the purpose of these guidelines.

CMD, SJVN shall be the ‘Appellate Authority’ in respect of such cases.
- iv) **“Investigating Committee”** shall mean any Officer/Committee appointed by Competent Authority to conduct investigation.
- v) **“List of approved Agencies viz Parties / Contractors / Suppliers/Bidders”** shall mean and include list of Parties/ Contractors / Suppliers / Bidders etc if registered with Employer.

4.0 Initiation of Banning / Suspension

Action for banning /suspension business dealings with any Agency shall be initiated by the department responsible for invitation of bids after noticing the irregularities or misconduct on the part of Agency concerned. Besides the concerned department, Vigilance Department of each Unit/ Corporate Vigilance may also be competent to initiate such action.

5.0 Suspension of Business Dealings.

- 5.1 If the conduct of any Agency dealing with Employer is under investigation, the Competent Authority may consider whether the allegations (under investigation) are of a serious nature and whether pending investigation, it would be advisable to continue business dealing with the Agency. If the Competent Authority, after consideration of the matter including the recommendation of the Investigating Committee, if any, decides that it would not be in the interest to continue business dealings pending investigation, it may suspend business dealings with the Agency. The order of suspension would operate for a period not more than six months and may be communicated to the Agency as also to the Investigating Committee. The Investigating Committee may ensure that their investigation is completed and whole process of final order is over within such period. However, if investigations are not completed in six months time, the Competent Authority may extend the period of suspension by another three months, during which period the investigations must be completed.
- 5.2 The order of suspension shall be communicated to all Departmental Heads of SJVN (including its subsidiaries and JVs) and Heads of the Units. During the period of suspension, no business dealing may be held with the Agency.



5.3 As far as possible, the existing contract(s) with the Agency may continue unless the Competent Authority, having regard to the circumstances of the case, decides otherwise.

5.4 If the Agency concerned asks for detailed reasons of suspension, the Agency may be informed that its conduct is under investigation. It is not necessary to enter into correspondence or argument with the Agency at this stage.

5.5 It is not necessary to give any show-cause notice or personal hearing to the Agency before issuing the order of suspension.

6.0 Ground on which Banning of Business Dealings can be initiated:

6.1 If the security consideration, including questions of loyalty of the Agency to Employer so warrants;

6.2 If the director /owner of the Agency, proprietor or partner of the firm, is convicted by a Court of Law for offences involving moral turpitude in relation to its business dealings with the Government or any other public sector enterprises, during the last three years.

6.3 If business dealings with the Agency have been banned by the Department of Power, Government of India and/or relevant Ministry/Govt. Deptt. of Nepal.

6.4 If the Agency has resorted to corrupt, fraudulent practices including misrepresentation of facts;

6.5 If the Agency uses intimidation / threatening or brings undue outside pressure on Employer or its official for acceptance / performances of the job under the contract;

6.6 If the Agency misuses the premises or facilities of Employer, forcefully occupies or damages Employer's properties including land, water resources, forests / trees or tampers with documents/records etc. (Note: The examples given above are only illustrative and not exhaustive. The Competent Authority may decide to ban business dealing for any good and sufficient reason).

7.0 Banning of Business Dealings

7.1 A decision to ban business dealings with any Agency shall apply throughout SJVN including its subsidiaries/JVs.

7.2 There will be an Investigating Committee consisting of officers not below the rank of AGM/DGM from Indenting Division, Finance, Law and Contracts. Member from department responsible for invitation of bids shall be the convener of the committee. The functions of the committee shall, inter-alia include:

- i) To study the report of the unit/division responsible for invitation of bids and decide if a prima-facie case for banning exists, if not, send back the case to the Competent Authority.



- ii) To recommend for issue of show-cause notice to the Agency by the concerned unit/division as per clause 9.1.
- iii) To examine the reply to show-cause notice and call the Agency for personal hearing, if required.
- iv) To submit final recommendations to the Competent Authority for banning or otherwise.

8.0 Removal from List of Approved Agencies - Suppliers/ Contractors, etc.

- 8.1 If the Competent Authority decides that the charge against the Agency is of a minor nature, it may issue a show-cause notice as to why the name of the Agency should not be removed from the list of approved Agencies - Suppliers / Contractors, etc.
- 8.2 The effect of such an order would be that the Agency would not be qualified for competing in Open Tender Enquiries or Limited Tender Enquiries till the period mentioned in the order.
- 8.3 Past performance of the Agency may be taken into account while processing approval of the Competent Authority for award of the contract.

9.0 Show-cause Notice

- 9.1 In case where the Competent Authority decides that action against an Agency is called for, a show-cause notice has to be issued to the Agency, Statement containing the imputation of misconduct or misbehavior may be appended to the show-cause notice and the Agency should be asked to submit within 15 days a written statement in its defense.
- 9.2 If the Agency requests for inspection of any relevant document in possession of Employer, necessary facility for inspection of documents may be provided.
- 9.3 The Competent Authority may consider and pass an appropriate speaking order:
 - a) For exonerating the Agency if the charges are not established;
 - b) For removing the Agency from the list of approved Suppliers / Contractors, etc.
 - c) For banning the business dealing with the Agency.
- 9.4 If it decides to ban business dealings, the period for which the ban would be operative may be mentioned.

10.0 Appeal against the Decision of the Competent Authority

- 10.1 The Agency may file an appeal against the order of the Competent Authority banning business dealing etc. The appeal shall be filed to Appellate Authority. Such an appeal shall be preferred within one month from the date of receipt of the order banning business dealing, etc.
- 10.2 Appellate Authority would consider the appeal and pass appropriate order which shall be communicated to the Agency as well as the Competent Authority.



11.0 Circulation of the names of Agencies with whom Business Dealings have been banned

- i) The concerned unit shall forward the name and details of the Agency(ies) banned to IT&SE Division of SJVN's Corporate Office for displaying the same on SJVN website.
- ii) Corporate Contracts Department, SJVN shall also forward the name and details of the Agency(ies) banned to the Ministry of Power, Gol besides forwarding the name and details to the contracts/procurement group of all CPSUs of power sector.



FORM OF DECLARATION OF ELIGIBILITY

UNDERTAKING

We,

M/s

_____ {Name and
address of bidder} hereby certify that we have not been banned/de-listed/ black listed /
debarred from business by any PSU / Govt. Department during last 03 (three) years on
the grounds mentioned in para 6 of Guidelines on banning of Business dealing.

(Seal & signature of the Contractor)